

RFXtrx / RFX User Guide



www.rfxcom.com

1. Table of Contents

1.	Table of Contents	2
2.	RFX general information.....	4
2.1.	RFX310 supported protocols.....	4
2.2.	RFXtrx315 supported protocols.....	4
2.2.1.	RFXtrx315 configured for 310MHz	4
2.2.2.	RFXtrx315 configured for 315MHz	4
2.3.	RFXtrx868X, RFXtrx868XL, RFX868 supported protocols.....	5
2.4.	RFXrec433, RFXtrx433, RFXtrx433E, RFXtrx433XL, RFX433 supported protocols	6
2.4.1.	By function	6
2.4.2.	Alphabetic list.....	10
2.5.	undec on	24
2.6.	Sensitivity influenced by enabled protocols	25
2.7.	RF range reduction.....	26
2.8.	Home Automation software	26
2.9.	Dimensions	26
2.10.	Electrical.....	26
2.11.	Environmental conditions.....	26
3.	Install the USB driver.....	27
4.	Run RFXflash on Linux under Mono.....	27
5.	RFXmngr test program.....	28
5.1.	Receiver.....	29
5.2.	Transmitter.....	30
6.	Flash update of the RFXtrx.....	31
6.1.	Update firmware in the RFXtrx	31
6.2.	Update firmware in the RFXtrx step by step	32
7.	RFX Wifi.....	34
7.1.	Restore Wifi settings	34
7.2.	Configure the RFX Wifi.....	34
7.3.	Flash the Wifi firmware in the RFX Wifi	35
7.4.	Use the USB port of the RFX Wifi for the RFX433/RFX868.....	36
7.5.	Add Wifi option to the RFXusb-RFX433	36
7.6.	Add the Wifi module to the RFX433XL-USB.....	36
8.	RFXtrx433 special device codes	37
8.1.	Remote commands	37
8.1.1.	X10 RF Remote	37
8.1.2.	ATI Remote Wonder.....	38
8.1.3.	ATI Remote Wonder Plus.....	39
8.1.4.	Medion Remote.....	40
8.2.	Harrison address conversion to switch settings.....	41
8.3.	Flamingo, AB400, IMPULS, Sartano, Brennenstuhl, SilverCrest 91089, Cranenbroek switch settings	42
8.4.	Energenie 5-gang 429.950	43
8.5.	Phenix, IDK YC-4000S switch settings	44
8.6.	HE105 switch settings	45
8.7.	HQ COCO-20.....	46
8.8.	MDREMOTE V106, V107	47
8.9.	MDREMOTE V108, EKAB-10KRF	47
8.10.	Aoke relay.....	47
8.11.	SEAV TXS4	48
8.12.	How to find the dx.com RGB LED strip driver ID	48
8.13.	How to find the dx.com RGB LED strip driver ID (rev. 2).....	48
8.14.	How to find the Eurodomest ID	48
8.15.	How to find the Screenline ID.....	49
8.16.	How to find the Avantek remote ID.....	49
8.17.	How to find the Siemens SF01 ID	49
9.	Blyss commands	50
10.	Somfy RTS	51

10.1.	How to move RFY devices to another RFXtrx433E, RFXtrx433XL or RFX433	52
11.	Dooya and compatibles	53
11.1.	BlindsT6	53
11.1.1.	Dooya DT52E, DT82TV, DT82TN.....	53
11.2.	Bi-directional DD27xx	53
12.	Cherubini	54
13.	ID switches Casafan and Lucci Air fans	55
14.	Transmit Funkbus (Insta, Gira, Jung, Berker)	56
15.	Transmit undecoded ARC commands.	57
16.	MCZ pellet stove.....	58
17.	Lighting4 devices	59
17.1.	Proluxx projection screen.....	59
17.2.	Kingpin (KP100) projection screen.....	59
17.3.	Mercury remote control mains sockets.....	59
17.4.	Conrad 034911 sockets	59
17.5.	Sonoff.....	60
17.6.	PT2262 and EV1527 oscillator resistors accepted	60
18.	Receive and Transmit RAW data.....	61
19.	RFXtrx433XL/RFX433 - P1 smart meter connection.....	63
19.1.	DIY P1 connection for RFXtrx433XL batch 3618 and 4018.....	64
19.2.	DIY P1 connection for RFXtrx433XL batch 4918 and later.....	64
19.3.	P1 option PCB Type 1 for RFXtrx433XL batch 3618 and 4018	65
19.4.	P1 option PCB Type 2 for RFXtrx433XL batch 4918 and later	66
19.5.	RFXusb-RFX433 - P1 smart meter connection	67
19.6.	RFX433XL - P1 smart meter connection.....	67
20.	RFXtrx433XL - Teleinfo connection	68
20.1.	Teleinfo option PCB for RFXtrx433XL batch 4918 and later.....	68
21.	RFXtrx433XL - Connection points for a serial interface.....	69
22.	Recover from interrupted or wrong flash.	70
23.	FAQ	73
23.1.	Receive has stopped suddenly but transmit works.....	73
23.2.	Can I increase the receive/transmit range of the RFXtrx?	73
23.3.	The RFXtrx USB connection disconnects sometimes.	73
23.4.	I have a 433.92MHz sensor/remote but this device is not received.....	73
23.5.	The wall plug is switched by the remote, the remote is received but the RFXtrx does not switch the module.	73
24.	EC Declaration of Conformity.....	74
25.	Warning:	75
26.	License	75
27.	Copyright notice.....	75
28.	Revision history	76

2. RFX general information

The RFXtrx/RFX transceivers and RFXrec receivers are communicating over an USB port with the Home Automation application. The RFX is powered by the USB port.

At startup the RFX enters for 2 seconds the boot loader (red LED is on) and after this it starts the receive/transmit firmware. If valid (decode-able) packets are received the yellow LED will blink.

The RFX310, RFXtrx315 and the RFXrec433 are mainly for use in the US. The RFXtrx315 can receive US X10 lighting and security sensors **or** US Visonic PowerCode sensors at 315MHz.

The RFXrec433 can receive weather sensors of different brands at 433.92MHz.

The RFX transceiver (transmitter+receiver) and can receive and control a large number of sensors and other devices.

The RFXtrx433E is an extended RFXtrx433 transceiver with additional memory and non-volatile memory for Somfy RTS codes and configuration settings.

The RFXtrx433XL is the next generation version with double size memory and a serial connection for the Dutch and French smart meters.

The RFX433 is an RFXtrx433XL with a new transceiver module and USB chip.

2.1. RFX310 supported protocols

Protocol	Protocol	Receive/Transmit
US X10 lighting	X10	R
US X10 security	X10	R

2.2. RFXtrx315 supported protocols

2.2.1. RFXtrx315 configured for 310MHz

Protocol	Protocol	Receive/Transmit
US X10 lighting	X10	RT
US X10 security	X10	RT

2.2.2. RFXtrx315 configured for 315MHz

Protocol	Protocol	Receive/Transmit
Aoke relay	Lighting5	T
PT2262, EV1527 and compatibles	Lighting4	RT
Keeloq (unencrypted part only)	Keeloq	R
Visonic CodeSecure (unencrypted part only)	Visonic	R
Visonic PowerCode	Visonic	RT

2.3. RFXtrx868X, RFXtrx868XL, RFX868 supported protocols

Protocol	Protocol	Receive/Transmit
Alecto ACH2010	Alecto ACH2010	R
Alecto WS5500, FineOffset WH2900, Ventus W830	FineOffset	R
Davis Vantage Vue EU *	Davis EU	R
Ecovitt WH31, WN32, WH40, WH51, WH57, WS90, WH5360	FineOffset	R
Edisio	Edisio	RT
FS20	FS20	RT
Gaposa rollermotor type QCTX	Gaposa	RT
Honeywell ActiveLink	Honeywell	RT
Itho CVE RFT	Itho CVE RFT	T
Itho CVE ECO RFT	Itho CVE ECO RFT	RT
Keeloq (unencrypted part only)	Keeloq	RT
Mi-Sol WH2900C	FineOffset	R
Orcon	Orcon	RT
Visonic CodeSecure (unencrypted part only)	Visonic	R
Visonic PowerCode	Visonic	R

* based on information available at: wxforum.net – “Implementing a Si1000 based wireless receiver for Davis ISS data” and madscientistlabs.blogspot.com

Important: it is only possible to enable one protocol for receive in the RFX868, RFXtrx868X and RFXtrx868XL because of the used transmission techniques at 868MHz.

2.4. RFXrec433, RFXtrx433, RFXtrx433E, RFXtrx433XL, RFX433 supported protocols

2.4.1. By function

Curtains, shades, projection screen, awning, gate openers
A-OK blind motors (RF01,AC114,AC123,AC127,AC129 controlled) - http://www.motorisationplus.com/
Aldomo - http://www.aldomo.de/
ASA ETR blind motors - http://www.asa-mingardi.org/en/home.php
ASP blind motors - http://www.asp-distribution.com/site%20volet/voletrenovation.aspx
BOFU EYB25 EY1612 blind motors - http://www.bofumotor.com/
BTX blind motors, remote, part# 490.2076 – http://www.btxinc.com
Brel blind motors - http://www.brel-motors.nl/webshop/motoren/ Bi-Directional only supported by RFX433.
Chamberlain CS4330CN http://www.chamberlain24.de/epages/es122868.sf/en_GB/?ObjectPath=/Shops/es122868/Products/RA4336
Cherubini
Confexx CNF24-2435
Dolat DLM-1 controlled motors - http://www.dolat.com.cn/product1.asp?id=538
Dooya blind motors, remotes tested: DC305,DC306,DC307,DC313,DC1602,DC1650,DC1651,DC2700 Bi-Directional only supported by RFX433.
Ematronic - http://www.ematronic.com/moteurs-volet-roulant/
ESMO blind motors
Faher
Forest blind/curtain motors - http://www.forestgroup.nl/index_nl.html
Gaposa ER motors QCTR 434.15MHz - http://www.gaposa.it/eng/products/residential-motors
Gaviota Bi-Directional only supported by RFX433.
Harrison curtain – http://www.harrison.nl/home2.htm
Hasta blind motors - http://www.hasta.se/
inblindz - https://www.inblindz.nl/
JVS screens - http://www.screen-discount.nl/
Jysk Huglo
Kimex projection screen - https://www.kimexinternational.com/A-9162-ecran-de-projection-electrique-encastrable-3-00-x-1-69m-format-16-9.aspx
Kingpin KP100 projection screen
Louvolite one touch motorised blinds
Luxaflex (RFXtrx433E and RFXtrx433XL and RFX433 only) - http://www.luxaflex.se/produkter/luxaflex/rullgardiner/
Media Mount Projector screen
mhz.de bi-directional
Motiva blinds, remote BY-305
Motolux - http://www.motolux.com.au/
Motostar blinds
Nobily rolladenmotor http://www.nobily.de/rolladenmotor/funk-elektronisch/40mm-achtkantwelle/170/nobily-rolladenmotor-pre4?c=5
Omnia Go blinds https://omniablinds.com/
Outlook Motion Blinds - https://www.spotlightstores.com/curtains-blinds/indoor-blinds/roller-blinds/project-outlook-motion-motorised-roller-blind/p/BP80360543
Ozroll E-Trans
Proluxx projection screen
Quotidom - http://www.quotidom.com/moteur-tubulaire-radio-quotidom-10-ou-20-nm-volet-roulant-ou-store-banne.html (not the Solutio version)
RAEX blind motor (YR1326 controlled)
RohrMotor24 RMF blind motors - http://www.rohrmotor24.eu/rohrmotor24
RollerTrol blind motors - http://rollertrol.com/
Screenline motors - http://www.screenline.cz/en/
Silverline Premium - http://www.aluparts.nl
Simu Hz (not BHz!) (RFXtrx433E and RFXtrx433XL and RFX433 only) – http://www.simu.com/
Siro - https://shop.siro-antrieb.de/shop-kategorie/elektrische-antriebe-fuer-innensonnenschutz/
Somfy (RFXtrx433E and RFXtrx433XL and RFX433 only) – http://www.somfy.co.uk/
Sunflower brand KT52E motorized Curtain track, Single track, DOOYA motor

https://nl.aliexpress.com/item/motorized-Curtain-track-1m-3-3m-wide-Single-track-DOOYA-motor-the-top-motor-brand-in/1939622604.html
Sunpery blind motors
YOODA blind motors – http://www.sukcesgroup.pl Bi-Directional only supported by RFX433

Temperature, humidity, weather sensors
Alecto – WSD10,WS1200, WS1700, WS3500, WS4500
Auriol – H13726
Ambient Weather - F007TH
Banggood – SKU174397 http://www.banggood.com/433MHz-Wireless-Weather-Station-Digital-Thermometer-Humidity-Sensor-p-965559.html
Blyss 630467
Bresser Temeo Hygro, 7009981,7009994, 7009997
Cresta
Digimax
Digoo DG-R8H DG-R8S
FineOffset WH1285
Froggit - F007TH
Hama – EWS1500
Hideki weather sensors
Honeywell – TF-ATS34C
Inovalley SM80 with plant probes - http://www.inovalley.com/detail.php?item_id=289
La Crosse
Lexibook – SM883
Marquant 943134
Maverick ET-732, ET-733 BBQ/Smoke temperature
Meade – TS33F-M, TS34C-M http://www.meade.com/products/weatherstations/sensors.html
Meteoscan – W155, W160
Nexa NBA-001
NEXUS – I008T
mi.sol WH2 http://www.ebay.com/itm/Transmitter-for-Wireless-Weather-Station-wireless-temperature-sensor-/121664060899
Opus XT300 /Imagintronix Soil sensor http://www.plantcaretools.com/en/webshop/wireless-moisture-sensor-en-detail http://www.ebay.co.uk/itm/Wireless-Soil-Moisture-Sensor-/251380900939?pt=UK Home Garden Plants Fertiliser CV&hash=item3a8778244b
Oregon Scientific / Huger
Pearl NC-7159 http://www.pearl.de/a-NC7159-3041.shtml
Prego P-8426 http://www.sunmarket.fi/tuote.asp?TID=11990
Proove –TSS320 & TSS330 fridge/freezer thermometer & outdoor sensors 311346,311501
RFXSensor
RUBiCSON – stektermometer 48659, 48695 -pool sensor p48019
Sunvic TLX1206
Sunvic TLX7506
TechnoLine/Proficell http://www.elv.de/output/controller.aspx?cid=74&detail=10&detail2=27621 - TX95-TH, WS9180-TX104
Telldus Thermo/Hygro sensors 313159 and 313160 https://www.lohelectronics.se/hemautomation/433mhz/sensorer-1110/smart-inne-och-utetermometer-med-hygrometer-10396
TFA
UPM/Esic (very short receiving range)
Ventus – WS155
Viking
WT0122 pool thermometer
Xiron –EN6

Door/window, smoke and other security sensors
Aidebao security
Alecto – SA30, SA33, SA41 smoke detector
AliExpress sensors with EV1572 or PT2262 (PT2262 is preferred)
Atlantic security
Chacon KD101 smoke detector
Chuang security
Digoo - https://www.aliexpress.com/item/DIGOO-433MHz-New-Door-Window-Alarm-Sensor-for-HOSA-HAMA-Smart-Home-Security-System-Suit-Kit/32957905665.html
Eminent security
Flamingo KD101 smoke detector FA20RF, FA21RF, FA22RF
Focus
Housegard Origo smoke detector
Kerui security https://www.aliexpress.com/item/433-MHz-Wireless-Door-Windows-Sensors-for-KERUI-Alarm-System-Magnetic-Door-Sensor-Door-Open-reminder/32590916896.html
Meiantech security
NEXA KD101/LM101LC smoke detector
Renkforce RF101 smoke detector
SAS SA-200 KD101 smoke detector
Smartwares RM174RF, RM175RF smoke detector
Oregon MSR939 https://www.redealer.de/multimedia/home-living/wetterstationen/bewegungssensor-msr939/a-200667/
Visonic CodeSecure
Visonic PowerCode
X10 security

Appliance modules, dimmers, relays, LED controllers
ANSLUT (learning mode)
Aoke relay http://www.aliexpress.com/store/product/whose-sale-prices-DC12V10A-Learning-Code-Wireless-Remote-Control-Switch-System-1-Receiver-and-1-Transmitter/1211856_1774391429.html
Avantek
ByeByeStandBy
Blyss lighting – http://www.castorama.fr/store/Prise-telecommandee-et-telecommande-BLYSS---Interieur-prod4470026.html
Brennenstuhl RC2044, RCS2044N
Chacon – http://www.chacon.be/
CoCo – http://www.coco-technology.com/en/home/
Conrad RSL2 – http://www.conrad.com/ce/en/product/640466/FUNK-STECKDOSENSCHALTER-RSLR2
Cotech Smarthome
Cranenbroek
DI.O – http://www.di-o.be/
DomiaLite
Ebode
ELRO AB400/AB600 – http://www.elro.eu/en/products/cat/home-automation/home-control1
Energenie ENER010 – 429.935, 5-gang 429.950 - https://energenie4u.co.uk/
Etekcitcity – http://etekcity.com/p-300-5-pack-wireless-remote-control-outlet-switch-set-with-2-remote-controls-zap-5lx.aspx
Eurodomest NL – Action
Everflourish EMW100
Flamingo
Flamingo FA500D FA500DSS
Flamingo Smartwares SF501
FunkBus (Gira, Jung, Insta, Berker)
Home Confort – http://www.home-confort.net/en
HomeEasy EU – http://www.elro.eu/en/products/cat/home-automation/
HomeEasy UK (including HE105 relay) – http://www.homeeasy.eu/
HQ COCO-20
Ikea Koppla

Impuls – NL – Action
Intertechno – http://www.intertechno.at/
Kambrook RF3672 – http://www.bunnings.com.au/kambrook-4-piece-indoor-powerpoint-kit-with-remote-control_p7030054
KlikAanKlikUit – http://www.klikaanklikuit.nl/home/
Legrand CAD radio – http://docdif.fr.grpleg.com/general/legrand-fr/NP-FT-GT/FA181DFR.pdf
LightwaveRF – http://www.lightwaverf.co.uk/
Livolo - http://www.livolo-france.com/fr/ http://nl.aliexpress.com/w/wholesale-livolo-touch-switch.html
Maplin http://www.maplin.co.uk/p/remote-controlled-mains-socket-set-single-n78ka (use Lighting1 – COCO GDR2)
MDremote LED dimmer V106, V107, V108, EKAB-10KRF - www.ultraleds.co.uk - http://www.ledstripkoning.nl/accessoires/dimmers-wit/draadloze-dimmer-10-knops-rf/
Mercury appliance modules – http://mercury.avsl.com/product?range=ME5124
NEXA – http://www.nexa.se/
ORNO
OTIO
Phenix
Philips SBC SP370 series
Profile Qnect 423000040,423000042
PROMax
Proove - http://proove.se/
Quigg
RGB LED strip driver dx.com - http://www.dx.com/ order nbr: 130913 (new TRC02 not supported) , 67412
RisingSun
Sartano
Siemens (UK)
SilverCrest 91089, 60494, 284705
Unitec 48110 EIM 826
Waveman
X10 RTS10 / RFS10
X10 lighting
Xdom

Remotes
ATI Remote Wonder
ATI Remote Wonder Plus
ATI Remote Wonder II
SEAV TXS4
X10 PC Remote

Chimes
1byOne Easy Chime
Alfawise - https://www.gearbest.com/ip-cameras/pp_1693842.html?wid=1214279
Byron SX and BY chime - http://www.chbyron.eu/Byron/ByronSXRange/68/89/
Byron MP001
Chacon
dBell - https://www.webstore4ipcmeras.nl/dbell_DB-HD-LIVE-B-W
Envivo – ENV1348
HomeEasy
KlikAanKlikUit
Monaco - https://www.airam.fi/en/product/v8305-2988/7020500/monaco-wireless-doorbell-230v/140/1
Profiles PAC-326R Belcanto
SelectPlus200689101 & SelectPlus200689103 (Action NL)

Power, gas water metering
Cartelectronic TIC, Encoder, Linky - https://www.cartelectronic.fr/index.php?id_product=124&controller=product
cent-a-meter
Electrisave
OTIO EHS5050
OWL CM113, CM180, CM119, CM160, CM180, CM180i - http://www.theowl.com/
Revolt NC5461 - http://www.pearl.de/a-NC5462-5452.shtml
RFXMeter

Specials
1byone Wireless Home Security Driveway Alarm http://www.1byone.co.uk/Home-Security/Alarms/O00QH-0511
CasaFan
DEA receivers http://www.deasystem.com/en/accessory/7/receivers (unencrypted only)
Gazco RF290A
Hunter TX36 fan
Lucci Air Fan - https://www.beaconlighting-europe.com/product-category/lucci-air-deckenventilatoren/
MCZ pellet stove
Mertik Maxitrol – Fire Place controllers
Novy extractor hood
Oregon Scientific Body weight scales – BWR101, BWR102, GR101
Prego P-8426 – sauna temperature sensor http://www.sunmarket.fi/tuote.asp?TID=11990
Smartwares radiator valve http://www.homewizard.nl/smartwares-draadloze-radiatorkraan.html
Siemens SF01 - LF959RA50/LF259RB50/LF959RB50 extractor hood
Wave Design extractor hood
X10 Ninja/Robocam – camera motor

2.4.2. Alphabetic list

Important notes:

- Ext, Ext2, Pro1 and Pro2 firmware can only be used in the RFXtrx433E!
- ProXL1, ProXL2 firmware can only be used in the RFXtrx433XL!
- RFX433 firmware can only be used in the RFX433!
- The RFX-433 is different from the RFX433. For the RFX-433 see the RFX User Guide.
- RFXrec firmware is equal to RFXtrx433 – Type1 firmware without the transmit functions.
- Protocol enabling is only necessary for receive. Transmit protocols are always enabled.
- R = Receive only
- T = Transmit only
- RT = Receive & Transmit

Device	RFXtrx433		RFXtrx433E				RFXtrx433XL		RFX433	Protocol
	Type1	Type2	Ext	Ext2	Pro1	Pro2	ProXL1	ProXL2		
1byOne Driveway Alarm http://www.1byone.co.uk/Home-Security/Alarms/O00QH-0511		RT	RT	RT	RT	RT	RT	RT	RT	ByronSX
1byOne Easy Chime		RT	RT	RT	RT	RT	RT	RT	RT	ByronSX
1byOne QH A19 rev10 Chime							RT	RT	RT	ByronSX
A-OK blind motors RF01 http://www.motorisationplus.com/	RT	RT		RT	RT	RT	RT		RT	BlindsT2
A-OK blind motors AC114,AC123,AC127,AC129, ZC11 - http://www.motorisationplus.com/	RT	RT		RT	RT	RT	RT		RT	BlindsT3
Aidebao security	RT	RT	RT	RT	R	R	R	R	R	Meiantech
Aldomo – http://www.aldomo.de/	T	T	T	T	RT	RT	RT		RT	BlindsT6
Alecto – SA30, SA33 smoke detector	RT		RT		RT		RT	RT	RT	Oregon
Alecto – WS1100 (needs correction -40°C)	R	R	R	R	R	R	R	R	R	FineOffset
Alecto – WS1200	R*	R*	R*	R*	R	R	R	R	R	*LaCrosse Pro = FineOffset
Alecto – WS1700 and compatibles, WS3500, WS4500			R	R	R	R	R	R	R	Rubicson
Alecto – WSD10				R	R	R	R	R	R	Rubicson
Alfawise – https://www.gearbest.com/ip-cameras/pp_1693842.html?wid=1214279							RT	RT		ByronSX
Ambient Weather F007TH, WS14 pool sensor				R	R	R	R	R	R	Oregon
ANSLUT (learning mode)	RT	RT	RT	RT	RT		RT	RT		AC
Aoke relay http://www.aliexpress.com/store/product/whose-sale-prices-DC12V10A-Learning-Code-Wireless-Remote-Control-Switch-System-1-Receiver-and-1-Transmitter/1211856_1774391429.html	RT	RT	RT	RT	RT		RT	RT	RT	Lighting5 Aoke or Lighting1 ARC
ASA ETR blind motors - http://www.asa-mingardi.org/en/home.php			T	T	T	T	T	T	T	RFY
ASP blind motors http://www.asp-distribution.com/site%20volet/voletrenovation.aspx	RT	RT		RT	RT	RT	RT		RT	BlindsT11
ATI Remote Wonder	R									ATI
ATI Remote Wonder Plus	R									ATI
ATI Remote Wonder II (only available in hardware version 1.0)	R									ATI
Atlantic security	RT	RT	RT	RT	RT	RT	RT	RT	RT	Meiantech

Device	RFXtrx433		RFXtrx433E				RFXtrx433XL		RFX433	Protocol
	Type1	Type2	Ext	Ext2	Pro1	Pro2	ProXL1	ProXL2		
Auriol H13726			R	R	R	R	R	R	R	Rubicson
Auriol Z31055B-TX				R	R	R	R	R	R	Rubicson
Avantek * receive Lighting4			RT	RT	RT	RT	RT	RT	RT	Lighting5 *Lighting4
Banggood – SKU174397			R	R	R	R	R	R	R	Rubicson
Banggood DANIU			R							Rubicson
Blyss lighting http://www.castorama.fr/store/Prise-telecommandee-et-telecommande-BLYSS--Interieur-prod4470026.html	RT	RT	RT		RT		RT	RT	RT	AE
Blyss temperature/humidity 630467	R	R	R				R	R		AE
BOFU EYB25 EY1612 blind motors - http://www.bofumotor.com/ * = receive in Type2 only used to get the remote ID.	T	RT	T	T	T		RT		RT	BlindsT0
Brennenstuhl RCS2044N	RT	RT	RT	RT	RT	RT	RT	RT	RT	Lighting4
Brennenstuhl RC2044				RT	RT		RT	RT	RT	Lighting4 + AC Pro = AC
Brel blind motors http://www.brel-motors.nl/webshop/motoren/	T	T	T	T	RT	RT	RT		RT	BlindsT6
Brel bi-directional									T	DD27xx
Bresser Temeo Hygro, 7009981, 7009994, 7009997, 7009998							R	R	R	Rubicson
BTX blind motors, remote, part# 490.2076 http://www.btxinc.com		T					T		T	BlindsT9
ByeByeStandBy	RT	RT	RT				RT	RT	RT	ARC
Byron BY chime					RT		RT	RT	RT	ByronSX
Byron DBY22321/23510									R	ByronSX
Byron DBY23711B/23712							RT	RT	RT	ByronSX
Byron SX chime http://www.chbyron.eu/Byron/ByronSXRange/68/89/	RT	RT	RT	RT	RT	RT	RT	RT	RT	ByronSX
Byron MP001 chime			T	T			T	T		Chime Byron MP001
CarteElectronic TIC, Encoder, Linky https://www.cartelectronic.fr/index.php?id_product=124&controller=product		R		R	R	R	R	R		ATI/cartelectronic
Casafan					T	T	T	T	T	Fan Casafan

Device	RFXtrx433		RFXtrx433E				RFXtrx433XL		RFX433	Protocol
	Type1	Type2	Ext	Ext2	Pro1	Pro2	ProXL1	ProXL2		
CasaFan Eco Aviatos RH787T					T	T	T	T	T	Fan LucciAir DCII
cent-a-meter	R	R	R							Oregon
Chacon (learning mode) http://www.chacon.be/	RT	RT	RT	RT	RT	RT	RT	RT	RT	AC
Chacon (with address code wheels)	RT	RT	RT	RT	RT		RT	RT	RT	ARC
Chacon EMW200	T	T	T				T	T	T	Lighting1 EMW200
Chacon 54660 (equal COCO GDR2)	T	T	T	T			T	T	T	Lighting1 COCO GDR2
Chacon KD101 smoke detector	RT	RT	RT	RT	RT	RT	RT	RT	RT	always on
Chamberlain CS4330CN http://www.chamberlain24.de/epages/es122868.sf/en_GB/?ObjectPath=/Shops/es122868/Products/RA4336			T				T		T	BlindsT8
Cherubini ID can be 10 30 00 to 10 3F FF							RT		RT	BlindsT18 (receive =BlindsTx + Keeloq)
Chuangou * decoded as X10	R	R	R	R*	R*	R*	R*	R*	R*	Lighting4
CoCo (learning mode) http://www.coco-technology.com/en/home/	RT	RT	RT	RT	RT	RT	RT	RT	RT	AC
CoCo (with address code wheels)	RT	RT	RT	RT	RT		RT	RT	RT	ARC
CoCo GDR2 (equal Chacon 54660)	T	T	T	T			T	T	T	Lighting1 COCO GDR2
Confexx CNF24-2435				T			T		T	BlindsT12
Conrad RSL2 http://www.conrad.com/ce/en/product/640466/FUNK-STECKDOSENSCHALTER-RSLR2	RT	RT		RT	RT		RT	RT	RT	RSL
Conrad RSL sensors		R					R	R	R	RSL
Conrad RSL2 motion/door-window sensors		R					R	R	R	RSL
Cotech Smarthome				RT	RT		RT	RT	RT	Lighting4 + AC,
Cotech weather sensor https://www.clasohlson.com/no/Ekstra-temperaturgiver-hygrometer/36-6726				R	R		R	R	R	Rubicson
Cranenbroek	T	T	T	T			T	T	T	Lighting1 Impuls
Cresta - TX-320, TS34C, anemometer, UV sensor, rain sensor	R	R	R	R	R	R	R	R	R	Hideki
Cuveo https://shop-m-e.de/produkte/cuveo-funk-system/?p=1						RT	RT	RT	RT	AE

Device	RFXtrx433		RFXtrx433E				RFXtrx433XL		RFX433	Protocol
	Type1	Type2	Ext	Ext2	Pro1	Pro2	ProXL1	ProXL2		
dBell – https://www.webstore4ipc cameras.nl/dbell_DB-HD-LIVE-B							RT	RT	RT	ByronSX
DEA receivers (unencrypted) http://www.deasystem.com/en/accessory/7/receivers			RT		RT	RT	RT	RT	RT	KeeLoq
Digimax	R	R	R	R	R		R	R	R	X10
Digoo DG-R8H, DG-R8S https://www.banggood.com/Digoo-DG-R8H-433MHz-Wireless-Digital-Hygrometer-Thermometer-Weather-Station-Sensor-for-TH11300-8380-p-1178108.html				R	R	R	R	R		Rubicson
Digoo DG-SD10 self-powered doorbell									R	Lighting4
Digoo https://www.aliexpress.com/item/DIGOO-433MHz-New-Door-Window-Alarm-Sensor-for-HOSA-HAMA-Smart-Home-Security-System-Suit-Kit/32957905665.html							R	R	R	Lighting4 + Meiantech
DI.O (learning mode) http://www.di-o.be/	RT	RT	RT	RT	RT	RT	RT	RT	RT	AC
DI.O (with address code wheels)	RT	RT	RT	RT	RT		RT	RT	RT	ARC
Dolat DLM-1 controlled motors http://www.dolat.com.cn/product1.asp?id=538		T				T	T		T	BlindsT10
DomiaLite (with address code wheels)	RT	RT	RT	RT	RT		RT	RT	RT	ARC
Dooya blind motors, emulate remotes: DC305, DC306, DC307, DC313, DC1602, DC1650, DC1651, DC2700	T	T	T	T	RT	RT	RT		RT	BlindsT6
Dooya bi-directional									T	DD27xx
Ebode	RT	RT	RT	RT	RT	RT	RT	RT	RT	X10
Electrisave	R	R	R		R	R	R	R		Oregon
ELRO AB400 http://www.elro.eu/en/products/cat/home-automation/home-control1	RT	RT	RT	RT	RT		RT	RT	RT	Lighting4
ELRO AB600	RT	RT	RT	RT	RT		RT	RT	RT	ARC
Ematronic RF01 http://www.ematronic.com/moteurs-volet-roulant/	RT	RT		RT	RT	RT	RT		RT	BlindsT2
Ematronic AC114, AC123 http://www.ematronic.com/moteurs-volet-roulant/	RT	RT		RT	RT	RT	RT		RT	BlindsT3
Eminent * decoded as X10 in ext firmware	RT	RT	RT	RT	RT	RT	RT	RT	RT	Lighting4
Energenie https://energenie4u.co.uk/ - ENER010 – 429.935, 5-gang 429.950	T	T	T				T	T	T	Lighting1 Energenie Energenie5
Envivo – Chime ENV1348			T				RT	RT	RT	Chime + Lighting4

Device	RFXtrx433		RFXtrx433E				RFXtrx433XL		RFX433	Protocol
	Type1	Type2	Ext	Ext2	Pro1	Pro2	ProXL1	ProXL2		
ESMO blind motors	T	T	T	T	RT	RT	RT		RT	BlindsT6
Etekcitey – http://etekcity.com/p-300-5-pack-wireless-remote-control-outlet-switch-set-with-2-remote-controls-zap-5lx.aspx	T	T	T				T	T	T	Lighting1 Energenie5
Eurodomest (NL – Action) * ARC only	T*	T	T*	T*			T	T	T	Lighting1 – ARC Or Lighting5 Eurodomest
Everflourish EMW100	T	T	T				T	T	T	Lighting5 EMW100
Falmec fan						T	T	T	T	Fan Falmec
Faro Barcelona fan – http://www.faro.es/			T		T	T	T	T	T	Fan LucciAir
Faro Barcelona DC fan For example : Airfusion Climate II 50 DC					T	T	T	T	T	Fan LucciAir DC
Faro Barcelona DCII fan For example : Airfusion Climate II 50 DC					T	T	T	T	T	Fan LucciAir DCII
Faher blinds motor	T	T	T	T	RT	RT	RT		RT	BlindsT6
FineOffset – WH1285 (needs correction -40°C)	R	R	R	R	R	R	R	R	R	FineOffset
Flamingo	RT	RT	RT	RT	RT	RT	RT	RT	RT	Lighting4
Flamingo FA500D FA500DSS				T	T		T	T	T	IT
Flamingo KD101 smoke detector FA20RF, FA21RF, FA22RF	RT	RT	RT	RT	RT	RT	RT	RT	RT	always on
Flamingo Smartwares SF501	R	R	R	R	R	R	R	R	R	AC
Focus	RT	RT	RT	RT	RT	RT	RT	RT	RT	Meiantech
Forest blind/curtain motors http://www.forestgroup.nl/index_nl.html	T	T	T	T			T		T	BlindsT7
Froggit – F007TH				R	R	R	R	R	R	Oregon
FT1211R fan controller					T	T	T	T	T	Fan FT1211R
FunkBus ID: 3F CC (Gira, Jung, Insta, Berker)						T	T	T	T	Funkbus
Gaposa ER motors QCTR 434.15MHz							RT		RT	BlindsT17
Gaviota	T	T	T	T	RT	RT	RT		RT	BlindsT6
Gaviota bi-directional									T	DD27xx
Gazco heater RF290A							RT	RT	RT	Mertik
HAMA EWS1500			R	R	R	R	R	R	R	Rubicson
Harrison curtain	T	T	T	T	T		T	T	T	Curtain Harrison

Device	RFXtrx433		RFXtrx433E				RFXtrx433XL		RFX433	Protocol	
	Type1	Type2	Ext	Ext2	Pro1	Pro2	ProXL1	ProXL2			
http://www.harrison.nl/home2.htm											
Hasta new blind motors http://www.hasta.se/ * = receive in Type2 only used to get the remote ID.	T	RT	T	T	T			RT		RT	BlindsT0
Hasta old blind motors	RT	RT						RT		RT	BlindsT1
Hideki weather sensors	R	R	R	R	R	R	R	R	R	R	Hideki
Home Confort lighting http://www.home-confort.net/en			RT					RT	RT	RT	HomeConfort
HomeEasy EU (learning mode) http://www.elro.eu/en/products/cat/home-automation/	RT	RT	RT	RT	RT	RT	RT	RT	RT	RT	HE EU
HomeEasy UK – HE105 - http://www.homeeasy.eu/	T	T	T	T				T	T	T	Thermostat2 HE105
HomeEasy UK (learning mode)	RT	RT	RT	RT	RT	RT	RT	RT	RT	RT	AC
HomeEasy UK (with address code wheels)	RT	RT	RT	RT	RT			RT	RT	RT	ARC
Honeywell - TF-ATS34C	R	R	R	R	R	R	R	R	R	R	Hideki
Housegard Origo smoke detector				RT	RT			RT	RT	RT	ARC
HQ COCO-20			T	T				T	T	T	Lighting1 HQ COCO20
Hualite blinds					T	T	T			T	BlindsT14
Hunter TX36 fan https://www.hunterfan.com/							RT	RT	RT	RT	Fan
Ikea Koppla	T						T				Lighting3
Impuls (NL – Action)	T	T	T	T				T	T	T	Lighting1 Impuls
inblindz – https://www.inblindz.nl/				T				T		T	BlindsT13
Inovalley SM80 with plant probes http://www.inovalley.com/detail.php?item_id=289			R	R	R	R	R	R	R	R	Rubicson
Intertechno (learning mode) http://www.intertechno.at/	RT	RT	RT	RT	RT	RT	RT	RT	RT	RT	AC
Intertechno (with address code wheels)	RT	RT	RT	RT	RT			RT	RT	RT	ARC
JVS screens http://www.screen-discount.nl/	T	T	T	T	RT	RT	RT			RT	BlindsT6
Jysk HUGLO	T	T	T	T	RT	RT	RT			RT	BlindsT6
Kambrook RF3672 – http://www.bunnings.com.au/kambrook-4-piece-indoor-powerpoint-kit-with-remote-control_p7030054		T	T					T	T		Lighting2 Kambrook
Keeloq (unencrypted)			RT		RT	RT	RT	RT	RT	RT	KeeLoq

Device	RFXtrx433		RFXtrx433E				RFXtrx433XL		RFX433	Protocol
	Type1	Type2	Ext	Ext2	Pro1	Pro2	ProXL1	ProXL2		
Kerui security * decoded as X10 in Ext2 and Pro firmware https://www.aliexpress.com/item/433-MHz-Wireless-Door-Windows-Sensors-for-KERUI-Alarm-System-Magnetic-Door-Sensor-Door-Open-reminder/32590916896.html	R	R	R	R*	R*	R*	R*	R*	R*	Lighting4 + X10*
Kerui siren xx xx x8 = on, xx xx x2 = off	T	T	T	T	T	T	T	T	T	Lighting4
Kimex projection screen https://www.kimexinternational.com/A-9162-ecran-de-projection-electrique-encastrable-3-00-x-1-69m-format-16-9.aspx	RT	RT		RT	RT	RT	RT		RT	BlindsT3
Kingpin KP100 projection screen	T	T	T	T	T	T	T	T	T	Lighting4
KlikAanKlikUit (learning mode) http://www.klikaanklikuit.nl/home/	RT	RT	RT	RT	RT	RT	RT	RT	RT	AC
KlikAanKlikUit (with address code wheels)	RT	RT	RT	RT	RT		RT	RT	RT	ARC
La Crosse - TX2, TX3, TX3P, TX4, TX7, TX17, WS2300	R	R	R	R	R	R	R	R	R	LaCrosse
La Crosse - rain sensor TX145R						R	R	R	R	Hideki
La Crosse - weather WS1652 - temp/hum TX141TH-Bv2, TX141W						R	R		R	LaCrosse
Legrand CAD radio			T				RT	RT	RT	Lighting5 LeGrand CAD
Lexibook - SM883	R	R	R	R	R	R	R	R	R	Hideki
LightwaveRF - http://www.lightwaverf.co.uk/	RT	RT	RT	RT	RT		RT	RT	RT	AD
Livolo - http://www.livolonederland.nl/ - http://www.livolo-France.com/fr/ - http://nl.aliexpress.com/w/wholesale-livolo-touch-switch.html	T	T	T	T	T		RT	RT	T	Lighting5 Livolo
Louvolite one touch motorised blinds * = receive in Type2 only used to get the remote ID.	T	RT	T	T	T		RT		RT	BlindsT0
Louvolite one touch Vogue vertical blinds * = receive only used to get the remote ID.							RT		RT	BlindsT0
Lucci Air fan https://www.beaconlighting-europe.com/product-category/lucci-air-deckenventilatoren/			T		T	T	T	T	T	Fan LucciAir
Lucci Air DC fan For example : Airfusion Climate II 50 DC					T	T	T	T	T	Fan LucciAir DC

Device	RFXtrx433		RFXtrx433E				RFXtrx433XL		RFX433	Protocol
	Type1	Type2	Ext	Ext2	Pro1	Pro2	ProXL1	ProXL2		
Lucci Air DCII fan For example : Airfusion Climate II 50 DC					T	T	T	T	T	Fan LucciAir DCII
Luxaflex – http://www.luxaflex.se/produkter/luxaflex/rullgardiner/			T	T	T	T	T	T	T	RFY
Maplin http://www.maplin.co.uk/p/remote-controlled-mains-socket-set-single-n78ka	T	T	T	T			T	T	T	Lighting1 COCO GDR2
Marquant 943134		R					R	R		X10
Maverick ET-732/733 BBQ/Smoke temperature	R	R	R	R	R		R	R		Hideki
MCZ pellet stove		RT	T				RT	RT	RT	Thermostat4
Mdremote LED dimmer V106 www.ultraleds.co.uk	T	T	T	T						Lighting5 MDRemote V106
Mdremote LED dimmer V107 www.ultraleds.co.uk	T	T	T	T						Lighting5 MDRemote V107
Mdremote LED dimmer V108, EKAB-10KRF http://www.ledstripkoning.nl/accessoires/dimmers-wit/draadloze-dimmer-10-knops-rf/	T	T	T	T						Lighting5 MDRemote V108
Meade – TS33F-M, TS34C-M http://www.meade.com/products/weatherstations/sensors.html	R	R	R	R	R	R	R	R	R	Hideki
Media Mount Projector screen		T								Lighting4
Meiantech security	RT	RT	RT	RT	RT	RT	RT	RT	RT	Meiantech
Mercury appliance modules http://mercury.avsl.com/product?range=ME5124	T	T	T	T			T	T	T	Lighting1 Energenie5
Mertik Maxitrol Fire Place controllers - G6R-H4T1, G6R-H4T5, G6R-H4TD, G6R-H4T16, G6R-H4TB, G6R-H4T21-Z22	RT	RT	RT	RT	RT		RT	RT	RT	Mertik
Mertik Maxitrol Fire Place controller – G6R-H3T1							RT	RT	RT	Mertik
Mertik Maxitrol Fire Place controller – G6R-H4S	T	T	T	T	T		T	T	T	Mertik
Meteoscan W155,W160			R	R	R	R	R	R	R	Rubicson
mhz.de bi-directional									T	DD27xx
Monaco – https://www.airam.fi/en/product/v8305-2988/7020500/monaco-wireless-doorbell-230v/140/1			T				RT	RT	RT	Chime + Lighting4
Motionblinds bi-directional									T	DD27xx
Motiva blinds, remote BY-305 * = receive in Type2 only used to get the remote ID.	T	RT	T	T	T		RT		RT	BlindsT0
Motolux blinds motor	T	T		T	T	T	T		T	BlindsT3
Motostar blinds						T	T		T	BlindsT15

Device	RFXtrx433		RFXtrx433E				RFXtrx433XL		RFX433	Protocol
	Type1	Type2	Ext	Ext2	Pro1	Pro2	ProXL1	ProXL2		
mi.sol WH2 http://www.ebay.com/itm/Transmitter-for-Wireless-Weather-Station-wireless-temperature-sensor-/121664060899	R	R	R	R	R	R	R	R	R	FineOffset
NEXA (learning mode) - http://www.nexa.se/	RT	RT	RT	RT	RT	RT	RT	RT	RT	AC
NEXA (with address code wheels)	RT	RT	RT	RT	RT		RT	RT	RT	ARC
NEXA KD101/LM101LC smoke detector	RT	RT	RT	RT	RT	RT	RT	RT	RT	always on
Nexa NBA-001 temperature sensor	R	R	R	R	R	R	R	R	R	Hideki
NEXUS - I008T	R	R	R	R	R	R	R	R	R	Hideki
Nobily rolladenmotor http://www.nobily.de/rolladenmotor/funk-elektronisch/40mm-achtkantwelle/170/nobily-rolladenmotor-pre4?c=5	T	T	T	T	RT	RT	RT		RT	BlindsT6
Novy extractor hood https://www.novynederland.nl/						T	RT	RT	RT	Fan
Oase Inscenio FM Master						T	T	T	T	Lighting1 Oase
Omnia Go blinds https://omniablinds.com/	T	T	T	T	RT	RT	RT		RT	BlindsT6
Opus XT300 /Imagintronix Soil sensor http://www.plantcaretools.com/en/webshop/wireless-moisture-sensor-en-detail http://www.ebay.co.uk/itm/Wireless-Soil-Moisture-Sensor-/251380900939?pt=UK_Home_Garden_Garden_Plants_Fertiliser_CV&h_ash=item3a8778244b	R*	R*	R*	R*	R	R	R	R	R	Imagintronix* Pro = Fineoffset
ORNO	RT	RT	RT	RT	RT	RT	RT	RT	RT	AC
Oregon Scientific / Huger BBQ and weather sensors - AW129, AW131, BTHGN129, BTHR918, BTHR918N, BTHR968, EW109, PCR800, RGR126, RGR682, RGR918, RGR928, RTGN318, RTGR328N, RTGR328N, RTGR368N, RTGR383, RTHN318, STR918, STR928, ,THGN800, THGN801, THC138, THC238, THC268, THGN122NX, THGN123N, THGN132ES, THGN132N, THGN500, THGR122(N/NX), THGR228(N/NF), THGR238, THGR268, THGR328N, THGR810, THGR918, THGR928, THGRN228NX, THN122N, THN129, THN132N, THR128, THR138, THR288(N/NF), THRN122N, THWR288A, THWR800, UV138, UVN128, UVN800, UVR128, WGR800, WGR918, WTGR800, WTGR800	R	R	R	R	R	R	R	R	R	Oregon
Oregon Scientific weighting scales - BWR101, GR101 US BWR101, BWR102 in RFXrec	R		R	R			R	R		Oregon
Oregon Scientific weighting scale BWR102	R		R	R			R	R	R	Oregon
Oregon MSR939 https://www.redealer.de/multimedia/home-living/wetterstationen/bewegungssensor-msr939/a-200667/			R				R	R	R	Oregon

Device	RFXtrx433		RFXtrx433E				RFXtrx433XL		RFX433	Protocol
	Type1	Type2	Ext	Ext2	Pro1	Pro2	ProXL1	ProXL2		
OTIO EHS5050		R					R	R	R	RSL
OTIO Lighting	RT	RT		RT	RT		RT	RT	RT	RSL
Outlook Motion Blinds https://www.spotlightstores.com/curtains-blinds/indoor-blinds/roller-blinds/project-outlook-motion-motorised-roller-blind/p/BP80360543		RT			RT	RT	RT		RT	BlindsT4
OWL – CM113	R	R	R				R	R	R	Oregon
OWL – CM119, CM160, CM180, CM180i http://www.theowl.com/	R	R	R	R	R	R	R	R	R	Oregon
Ozroll E-Trans								RT		BlindsTx
Pearl NC-7159 http://www.pearl.de/a-NC7159-3041.shtml			R	R	R	R	R	R	R	Rubicson
Phenix	RT	RT	RT	RT	RT	RT	RT	RT	RT	Lighting4
Philips SBC SP370 series		T					T	T	T	Lighting1 Philips SBC
Prego P-8426 http://www.sunmarket.fi/tuote.asp?TID=11990	R	R	R		R		R	R		X10 Pro1/ProXL1 = Rubicson
Profile Qnect 423000040,423000042				RT	RT	RT	RT	RT	RT	Lighting4 + AC Pro = AC
Profiles PAC-326R Belcanto	RT	RT	RT	RT	RT	RT	RT	RT	RT	ByronSX
Profitec KD310T https://akkuplus.de/profitec-KD-310-T-Energiekosten-Messgeraet-Sender		R		R			R	R	R	RSL
Proluxx projection screen	T	T	T		T	T	T	T	T	Lighting4
PROMax				T	T	T	T	T	T	IT
Proove –TSS320 & TSS330 fridge/freezer thermometer & outdoor sensors 311346,311501	R	R	R	R	R	R	R	R	R	FineOffset
Quigg RC DS5 4001-A DE 3726				RT	RT		RT	RT	RT	Lighting4 + AC Pro = AC
Quotidom – http://www.quotidom.com/moteur-tubulaire-radio-quotidom-10-ou-20-nm-volet-roulant-ou-store-banne.html (not the Solutio version)	T	T	T	T	RT	RT	RT		RT	BlindsT6
RAEX blind motor (YR1326 or YRL2016 controlled)		RT					RT	RT	RT	BlindsT4
Rain sensor - https://nl.aliexpress.com/item/4000761757290.html	RT	RT		RT	RT	RT	RT		RT	BlindsT3
RAW data					RT	RT	RT	RT	RT	undec on
Renkforce RF101 smoke detector	RT	RT	RT	RT	RT	RT	RT	RT	RT	always on
Revolt NC5461 http://www.pearl.de/a-NC5462-5452.shtml		R		R			R	R		RSL
RFXSensor	R	R	R	R	R	R	R	R	R	X10

Device	RFXtrx433		RFXtrx433E				RFXtrx433XL		RFX433	Protocol
	Type1	Type2	Ext	Ext2	Pro1	Pro2	ProXL1	ProXL2		
RFXMeter	R	R	R	R	R	R	R	R	R	X10
RGB LED strip driver dx.com - http://www.dx.com/ order nbr: 130913, (new TRC02 NOT supported) - http://www.dx.com/ order nbr: 67412 * = receive only in Type2 used to get the RGB remote ID.	T	RT	T							AD
RGB432W LED controller	T	T	T							Lighting5 RGB432W
RisingSun	RT	RT	RT	RT			RT	RT		Lighting4
RUBICSON - stektermometer 48659, 48695 -pool sensor p48019	R		R	R	R	R	R	R	R	Rubicson
RohrMotor24 RMF blind motors http://www.rohrmotor24.eu/rohrmotor24	T	T	T	T	RT	RT	RT		RT	BlindsT6
RollerTrol R-series blind motors - http://rollertrol.com/ * = receive in Type2 only used to get the remote ID.	T	RT	T	T	T		RT		RT	BlindsT0
Rollertrol G-series blind motors	T	T	T	T	RT	RT	RT		RT	BlindsT6
Sartano	RT	RT	RT	RT	RT		RT	RT	RT	Lighting4
SAS SA-200 smoke detector	RT	RT	RT	RT	RT	RT	RT	RT	RT	always on
Screenline motors - http://www.screenline.cz/en/ Remote- SL2392S159 - Pellini				T			T		T	BlindsT13
SEAV TXS4				T			T	T		FAN SEAV TXS4
SelectPlus200689101 & SelectPlus200689103 (Action NL)		RT	RT	RT	RT	RT	RT	RT	RT	ByronSX
Siemens SF01 LF959RA50/LF259RB50/LF959RB50 extractor hood		T					RT	RT	RT	Homecomfort,Fan SF01
Siemens (UK)	RT	RT	RT	RT	RT		RT	RT	RT	AD
SilverCrest 91089	RT	RT	RT				RT	RT	RT	Lighting4
SilverCrest 60494, 284705				RT	RT		RT	RT	RT	Lighting4 + AC Pro = AC
Silverline Premium - http://www.aluparts.nl	T	T	T	T	RT	RT	RT		RT	BlindsT6
Simu Hz / RTS - http://www.simu.com/			T	T	T	T	T	T	T	RFY
Siro	T	T	T	T	RT	RT	RT		RT	BlindsT6
Smartwares radiator valve http://www.homewizard.nl/smartwares-draadloze-radiatorkraan.html			T	T	T	T	T	T		Radiator1 Smartwares
Smartwares RM174RF, RM175RF, SA41				R	R	R	RT	RT	RT	Ext2 = ARC else = Lighting4
Somfy / RTS http://www.somfy.co.uk/			T	T	T	T	T	T	T	RFY

Device	RFXtrx433		RFXtrx433E				RFXtrx433XL		RFX433	Protocol
	Type1	Type2	Ext	Ext2	Pro1	Pro2	ProXL1	ProXL2		
To control Somfy Centralis use RFY2 commands.										
Sonoff RF	RT	RT	RT	RT	RT	RT	RT	RT	RT	Lighting4
Sunperly blind motors		T					T		T	BlindsT9
Sunvic TLX1206	RT	RT	RT		RT		RT	RT	RT	X10
Sunvic TLX7506	R	R	R		R		R	R	R	X10
TechnoLine/Proficell http://www.elv.de/output/controller.aspx?cid=74&detail=10&detail2=2762 1 - TX95-TH, WS9180-TX104	R		R	R	R	R	R	R	R	Rubicson
Telldus 312716,313159,313160 https://www.lohelectronics.se/hemautomation/433mhz/sensorer-1110/smart-inne-och-utetermometer-med-hygrometer-10396	R	R	R	R	R	R	R	R	R	FineOffset
TFA - TS15C, TS34C, 30.3245.02, 30.3139 external temperature / humiditysensor 30.3133, anemometer 30.3149, UV sensor, rain sensor 30.3148, pool sensor 30.3160	R	R	R	R	R	R	R	R	R	Hideki
TFA - pool sensor 30.3056.10, 30.3216.20 - external temperature sensor 30.3208.02 - temperature sensor 30.504554				R	R	R	R	R	R	Oregon
TFA - rain sensor 30.3233, 30.3252						R	R	R	R	Hideki
TFA - weather Pro 35.1161.01 - temp/hum 30.3249.02, 30.3221.02 - anemometer 30.3222.02, 30.3251.10						R	R		R	LaCrosse
TFA - temp/hum 30.3247.02							R	R	R	Rubicson
UPM/Esic (very short receiving range) WT260,WT260H,WT440H,WT450,WT450H,WDS500, RG700	R				R		R	R	R	Hideki
Unitec 48110 EIM 826				RT	RT		RT	RT	RT	Lighting4 + AC Pro = AC
Ventus WS155			R	R	R	R	R	R	R	Rubicson
Viking - 02035, 02038, 02811	R	R	R	R	R	R	R	R	R	FineOffset
Visonic CodeSecure	R	R	R	R	R	R	R	R	R	Visonic
Visonic PowerCode	R	R	R	R	RT	RT	R	R	R	Visonic

Device	RFXtrx433		RFXtrx433E				RFXtrx433XL		RFX433	Protocol
	Type1	Type2	Ext	Ext2	Pro1	Pro2	ProXL1	ProXL2		
Wave Design extractor hood	T	T	T	T			T	T	T	Fan SF01
Waveman	T	T	T	T			T	T	T	Lighting1 Waveman
Westinghouse fan 7226640				T			T	T	T	Fan
WT0122 pool sensor			R		R	R	R	R	R	FineOffset
YOODA blind motors http://www.sukcesgroup.pl	T	T	T	T	RT	RT	RT		RT	BlindsT6
Yooda bi-directional									T	DD27xx
X10 Ninja/Robocam		RT								X10
X10 PC Remote	RT									X10
X10 RTS10 / RFS10	RT	RT	RT	RT	RT	RT	RT	RT	RT	X10
X10 lighting	RT	RT	RT	RT	RT	RT	RT	RT	RT	X10
X10 security	RT	RT	RT	RT	RT	RT	RT	RT	RT	X10
Xdom	RT	RT	RT	RT	RT	RT	RT	RT	RT	X10
Xiron – EN6	R		R	R	RT	R	R	R	R	Rubicson

2.5. *undec on*

If new sensor types are released, they will most probably not be decoded by the RFXtrx firmware. For this reason, we have added the option to enable receive of undecoded messages. This function is only to enable RFXCOM to add this new sensor type in the firmware if possible. If “undec on” is enabled in normal use the application will receive a lot of undecoded messages mostly as a result of RF noise or disturbed RF packets.

It can also be used to receive an unknown remote and use the RAW data to create RAW transmit commands.

Important: For normal use “undec on” should be disabled

2.6. Sensitivity influenced by enabled protocols

All protocols can be enabled in the **Pro firmware** versions; however, it is still preferred to enable only the protocols used for receive.

The sensitivity of the receiver part is highly influenced by the number of protocols enabled in Type1, Type2, Ext or Ext2 firmware. Lesser protocols enabled will make the receiver more sensitive for the enabled protocols.

There are a few protocols that will reduce or even eliminate receiving of other protocols if enabled in Type1, Type2, Ext or Ext2 firmware.

For example:

If the AD (LightwaveRF, Siemens) protocol is enabled it can stop receiving of Meiantech / Atlantic, Oregon 3.0, Visonic and Mertik.

All other protocols are disabled if BlindsT0 is enabled in Type1, Type2, Ext, Ext2 or RFX433 firmware.

	X10	ARC	AC	HomeEasy EU	Meiantech/Atlantic	Oregon 1.0	Oregon 2.1	Oregon 3.0 / OWL	ATI	Visonic/Keeloq	Mertik	AD (LWRF)	Hideki/UPM	La Crosse	FS20	ProGuard	BlindsT0	BlindsT1/T2/T3/T4	AE (Blyss)	Rubicson/Alecto	FineOffset/Viking	Lighting4	RSL/Revolt	Byron SX	Imagintronix/Opus	HomeComfort
X10																										
ARC																										
AC																										
HomeEasy EU																										
Meiantech/Atlantic																										
Oregon																										
ATI																										
Visonic/Keeloq																										
Mertik																										
AD (LWRF)																										
Hideki/UPM																										
La Crosse																										
FS20																										
ProGuard																										
BlindsT0																										
BlindsT1/T2/T3																										
AE (Blyss)																										
Rubicson																										
FineOffset/Viking																										
Lighting4																										
RSL																										
Byron SX																										
Imagintronix																										
HomeComfort																										

Green = enabled by default

2.7. RF range reduction

The RF signals operating distance is reduced when the signal has to pass through walls.

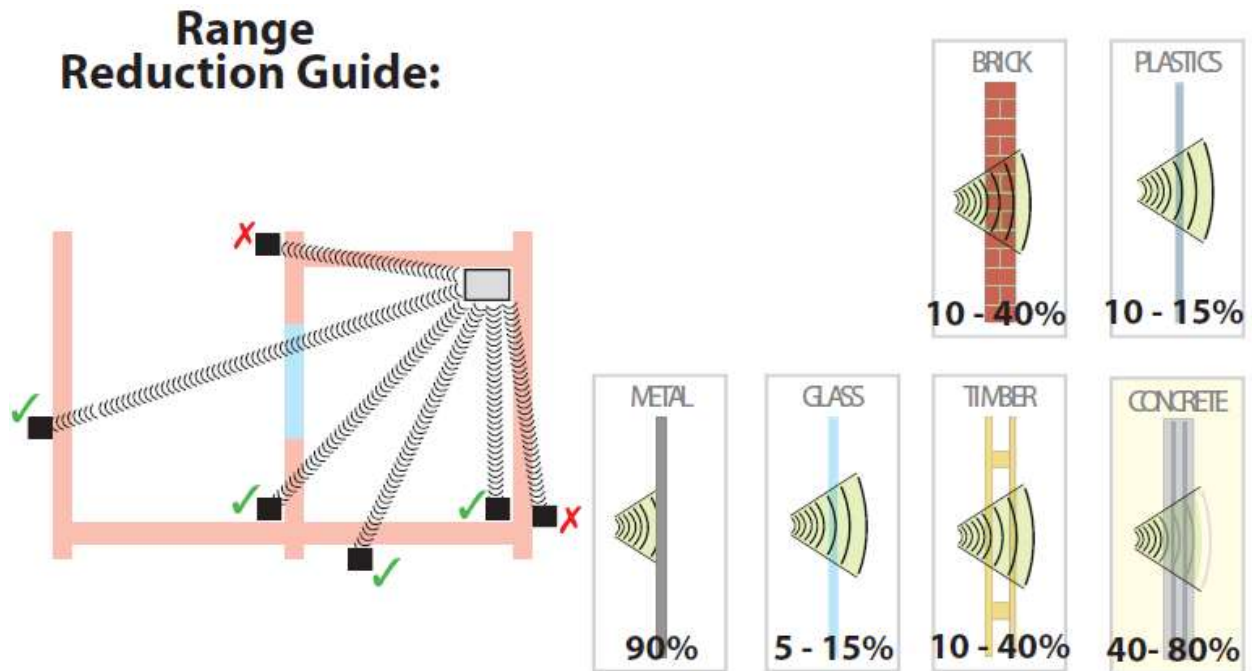

2.8. Home Automation software

For the list of Home Automation software that supports the RFXtrx see the web site www.rfxcom.com

2.9. Dimensions

The dimensions of the enclosure: 83.5 x 42 x 15 mm
Total height from bottom to antenna top is 122mm

2.10. Electrical

The RFXtrx is powered by the 5 Volt of the USB interface.

Operating current;

Receive mode: 28 mA (0.14Watt)
Transmit mode: 45 mA

The RFXtrx Radiated RF power is 10dBm max.

2.11. Environmental conditions

Normal operating: 15°C to 35°C
Absolute min-max temperature: -10°C to 55°C

3. Install the USB driver

The RFXtrx has the FTDI FT232R USB interface chip installed.

The RFXtrx433XL has the FTDI FT230XQ USB interface chip installed.

The USB drivers are available at <http://www.ftdichip.com/Drivers/VCP.htm>

The RFXusb-RFX433 and RFX433XL-USB, RFX433XL-Wifi, RFX433XL-LAN and RFX868XL-USB, RFX868XL-Wifi and RFX868XL-LAN have the CP2102N USB interface chip installed.

The USB drivers are available at:

<https://www.silabs.com/developers/usb-to-uart-bridge-vcp-drivers?tab=downloads>

4. Run RFXflash on Linux under Mono

Open a Terminal screen in Linux (Ctrl-Alt-T)

Execute once:

Install Mono:

```
[sudo] apt-get install mono-runtime
```

Install VisualBasic support under Mono:

```
[sudo] apt-get install libmono-microsoft-visualbasic8.0-cil
```

If the USB device is created as ttyACMx you will need to create a link between /dev/ttyACMx and a serial port /dev/ttySx.

This is not necessary if the device is created as /dev/ttyUSBx !!

```
[sudo] ln -sf /dev/ttyACM1 /dev/ttyS3
```

Note: sudo must be entered without brackets []. sudo is required if not running as super user.

Launch the RFXflash.exe program.

```
[sudo] mono RFXflash.exe
```

Note: RFXmngnr does not operate under mono!

5. RFXmngtr test program

The RFXmngtr Windows program supports decoding of received data and allows you to transmit commands.

RFXmngtr can only be used with Windows!

A good alternative on other OS systems is: https://github.com/ssjoholm/rfxcmd_gc

After the connection the RFXmngtr program transmits a Reset and Get Status command so that it will know the RFXtrx type and configuration settings:

The screenshot shows the RFXmngtr application window. The configuration section includes:

- Transceiver type: RFXtrx433
- Receiver freq.: 433.92
- Buttons: Set Mode, Save Settings, Reset RFXtrx, Get Status
- Timestamp:
- Protocol checkboxes: undec on, Imagintronix, Byron SX, RSL, Lighting4, FineOffset, Rubicson, AE Blyss, BlindsTx, BlindsT0, LeGrand CAD, Hideki, AD LightwaveRF, Mertik, Visonic, ATI, Oregon Scientific, Meiantech, HomeEasy EU, AC, ARC, X10, HomeCorfort, Keeloq.
- FW version: 1028, FW type: Pro1, Xmit power: +10 dBm, HW version: 1.0, Noise level: 102.

The terminal log shows the following output:

```
RFXtrx433 COM5 Serialnr: A12GLGHK
-----
26-Sep-18 04:09:52:205= Reset receiver/transceiver
-----
26-Sep-18 04:09:52:696= Get Status
-----
26-Sep-18 04:09:52:801
Packettype = Interface Message
subtype = Interface Response
Sequence nbr = 1
response on cmdnd = Get Status
Transceiver type = 433.92MHz
Firmware version = 1028
Firmware Type = Pro1
Noise level = 102
Transmit power = 10dBm
Hardware version = 1.0
Undec off
Imagintronix disabled
Byron SX disabled
RSL disabled
Lighting4 disabled
FineOffset disabled
Rubicson disabled
AE Blyss disabled
```

Transmitter protocols are always enabled but receiver protocols can be disabled. This is very useful because the receiver will become more sensitive when protocols not used are disabled. Select only the protocols to be used for receiving, click **Set mode** and click **Save Settings**.

Note that these settings are lost in Type1 and Type2 firmware after a firmware update and need to be set again.

5.1. Receiver

The RF protocols to be received can be configured on the Main tab at **Set Mode**.

Click **Save Settings** to save the selected protocols in non-volatile memory of the RFXtrx. This configuration is now restored every time after a power up.

Note that these settings are lost after a firmware update in Type1 or Type2 firmware and need to be set again.

Note: Protocol enabling is only necessary for receive. Transmit protocols are always enabled.

The received RF data is decoded and displayed in the yellow window.

RFXmngn

File Information

Main Lighting1 Lighting2 Lighting3 Lighting4 Lighting5 L

Transceiver type RFXtrx433 und

Receiver freq. 433.92 Ima

Byrc

RSL

Ligh

Fine

Rub

AEI

Reset RFXtrx

Get Status

```
RFXtrx433 COM5 Serialnr: A12GLGHK
-----
26-Sep-18 04:09:52:205= Reset receiver/transce
-----
26-Sep-18 04:09:52:696= Get Status
-----
26-Sep-18 04:09:52:801
Packettype      = Interface Message
subtype        = Interface Response
Sequence nbr    = 1
response on cmdnd = Get Status
Transceiver type = 433.92MHz
Firmware version = 1028
Firmware Type  = Prol
```

5.2. Transmitter

The tabs after the Main tab are used to send commands to the transmitter.

For example, Lighting1 is used to send X10, ARC and some more.

Note: Protocol enabling is only necessary for receive. Transmit protocols are always enabled.

Select Type to see which protocols are supported on the different tabs.



The transmitted commands are displayed in the yellow window including the acknowledge send by the RFXtrx, in the example above “ACK, data correct transmitted“.

6. Flash update of the RFXtrx

6.1. Update firmware in the RFXtrx

Firmware is flashed in the RFXtrx using this procedure:

1. Depending on the RFXtrx type download the latest .hex firmware file.
2. Connect the RFXtrx to a Windows system or Linux under MONO
3. Stop any program that is connected to the RFXtrx.
4. Start the RFXflash program with administrator rights (version 12.0.0.0 or higher)
5. Select the USB RFXtrx COM port or TCP/IP port and click the CONNECT button, (the red LED on the RFXtrx should switch on now)
6. Load the correct .hex firmware file for your RFXtrx,
7. Click the WRITE button,
8. Click the Normal Execution mode button.

IMPORTANT:

1. Do not interrupt the flash procedure when started.
2. It can happen that the flash procedure ends with a pop-up screen indicating errors. Just disconnect the RFXtrx and start again at step 5 until the flash procedure is finished without errors.

If the red LED does not switch on if you click the CONNECT button:

1. Check if you have selected the correct USB COM port.
2. If you have flashed the RFXtrx before and interrupted the flash procedure it is possible that the RFXtrx does not enter the flash state. Contact support@rfxcom.com for help.

Note: Receiver Settings are lost in Type1 and Type2 firmware after a firmware update and must be set again.

6.2. Update firmware in the RFXtrx step by step

- Click the Connect to Device button.

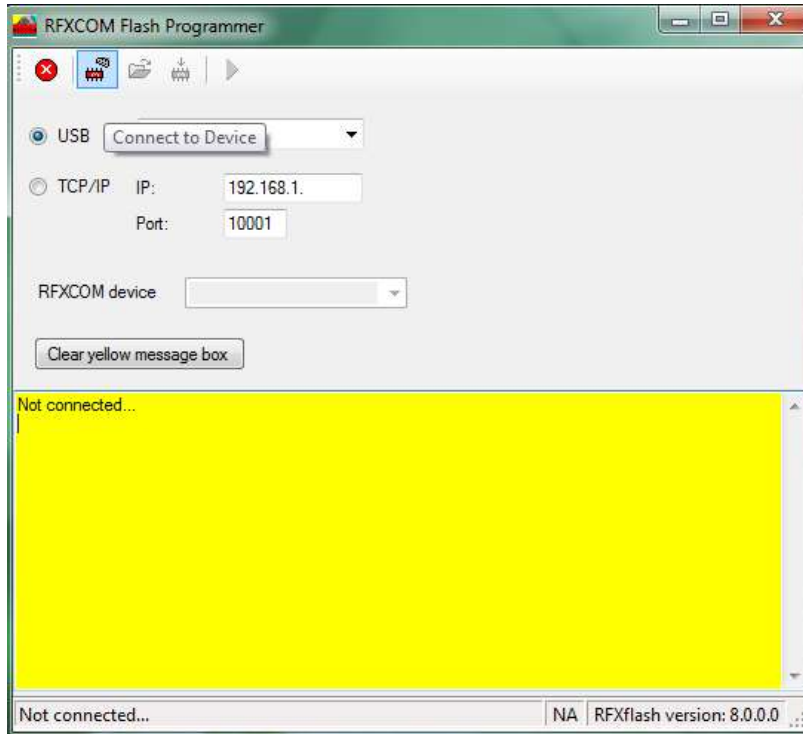

The RFXtrx will automatically switch from normal mode to the bootloader now.

- Click the Open HEX file button and load the RFXtrx $yyy??$ _ zz .hex file
Be sure to load the latest firmware file for the RFXtrx.
 yyy indicates the RFXtrx frequency, so load the RFXtrx433 for an RFXtrx433!
 $??$ this is XL for the RFXtrxXL versions.
 zz indicates the firmware version.

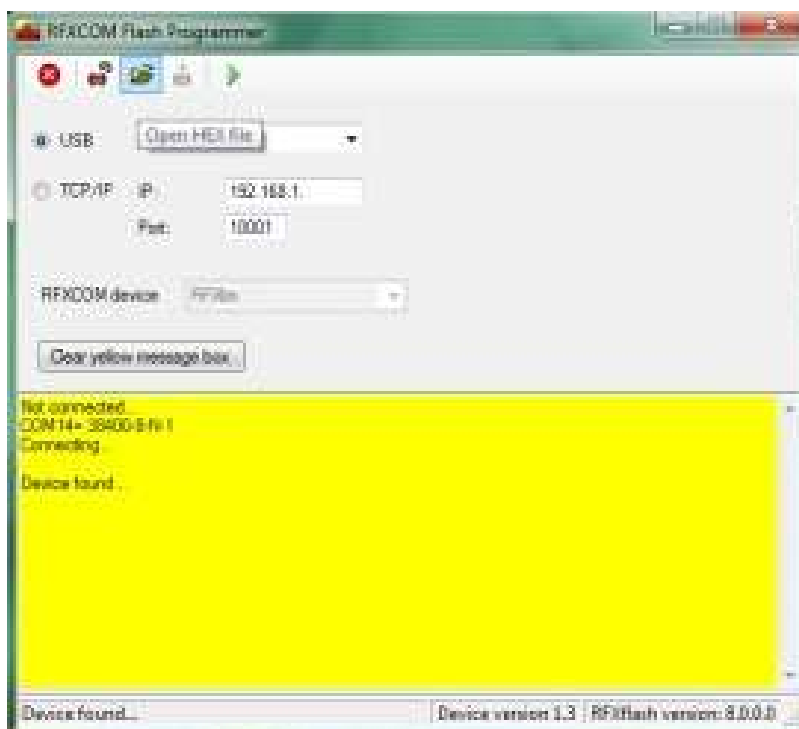

- Click the Write device button and the RFXtrx is flashed.

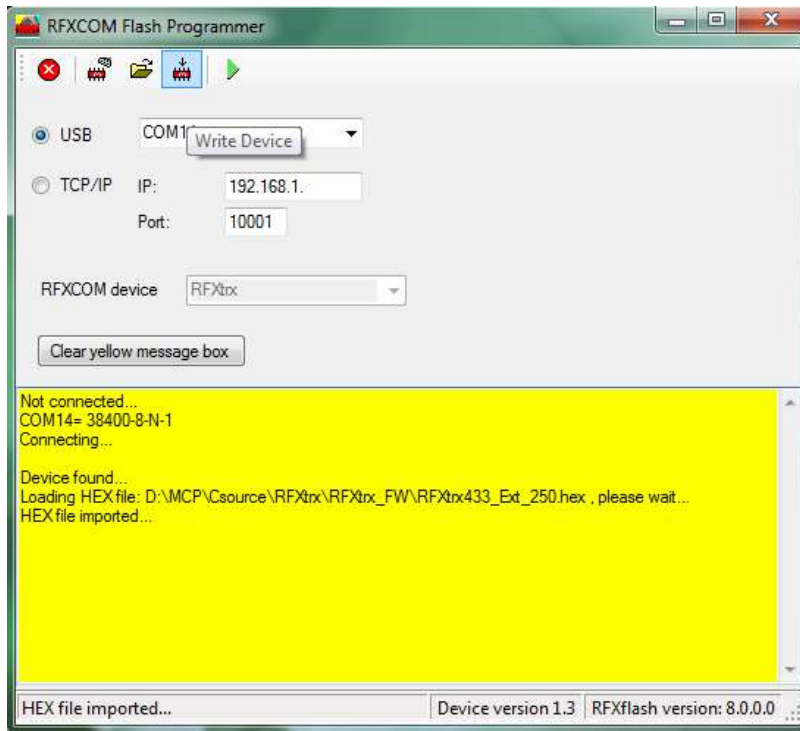

- Click on the Normal Execution Mode button to set the RFXtrx to running mode.

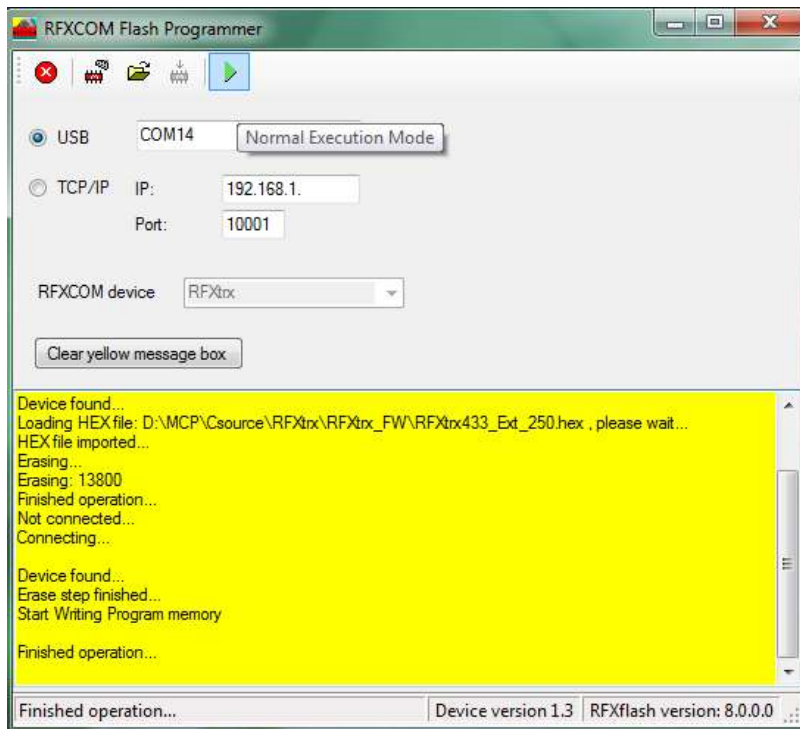

Note: Receiver Settings are lost in Type1 and Type2 firmware after a firmware update and must be set again.

7. RFX Wifi

7.1. Restore Wifi settings

To reset the Wifi settings to factory settings, disconnect the power, press and keep the RESTORE button, connect the power. If a pin hole with the text “Restore” is present on the back side of the enclosure, use a small pin to push the restore button else open the enclosure.

7.2. Configure the RFX Wifi.

Connect the RFX Wifi to an USB or the external 5V 1A power supply.

Open the Wifi network settings on your PC or mobile and connect the access point RFXCOM WiFi Manager and use **password: 12345678**

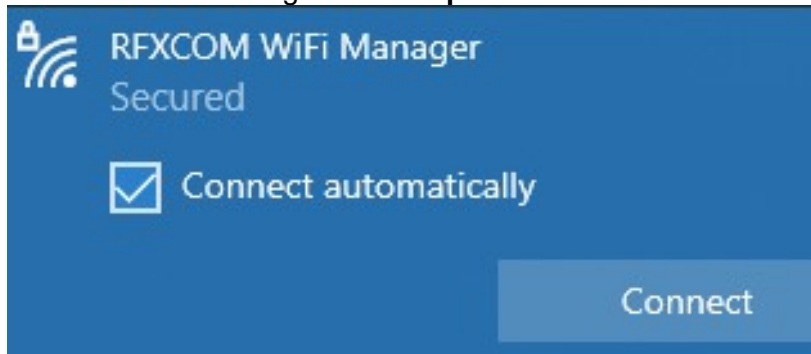

Open a browser and open **192.168.4.1** and enter your Wifi credentials, SSID and password of your Wifi network.

Optional enter a Local IP with Subnet Mask and Gateway, for example:

192.168.1.150

255.255.255.255.0

192.168.1.1

DHCP is used if no Local IP, Subnet Mask, Gateway info is entered



Enter your WiFi credentials

for DHCP do not enter any value at Local IP, Subnet Mask and Gateway

SSID:	<input type="text"/>
Key:	<input type="text"/>
Local IP:	<input type="text"/>
Subnet Mask:	<input type="text"/>
Gateway:	<input type="text"/>
<input type="button" value="Save"/>	

Click Save and the RFX Wifi will restart and connect your Wifi.

7.3. Flash the Wifi firmware in the RFX Wifi

- Download the Arduino IDE to flash the ESP32 in the RFX Wifi with new firmware. <https://www.arduino.cc/en/software>
- In Arduino IDE:
File – Preferences and add at Additional boards manager URLs:
https://dl.espressif.com/dl/package_esp32_index.json
- Open Tools – Board: “xxxxxx” -Boards Manager
At BOARDS MANAGER enter ESP32 and INSTALL the latest version “esp32 by Espressif Systems”.
- Select “ESP32 Dev Module” at Tools – Board: “xxxx” – esp32

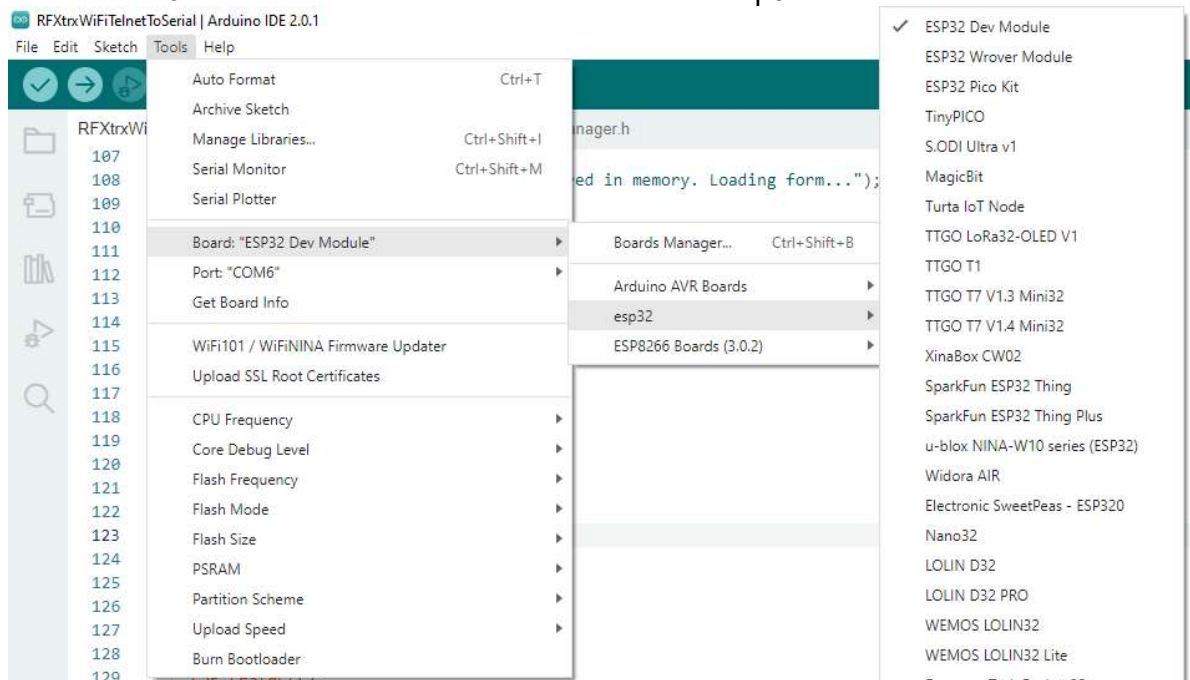

- Select the COM port of the RFX Wifi at Tools – Port
- To know the Sketchbook location open File – Preferences – Settings.
Copy the RFXtrxWiFiTelnetToSerial directory to your Arduino sketch directory
RFXtrxWiFiTelnetToSerial directory contains:
 - HTML.h
 - revisions.txt
 - RFXtrxWiFiTelnetToSerial.ino
 - WifiFunc.h
- Open RFXtrxWiFiTelnetToSerial.ino and click the Upload button. The firmware will be compiled and flashed in the RFX Wifi ESP32



7.4. Use the USB port of the RFX Wifi for the RFX433/RFX868

The USB port is normally only used to power the RFX Wifi or to flash the ESP32 module. With the default delivered Wifi firmware in the ESP32 you have to use Wifi for RFXmngnr and RFXflash.

To use the USB port to communicate with the RFX433/868 you must flash the ESP32 with special USB firmware.

Copy the RFXtrxUSB directory to your Arduino sketch directory. The RFXtrxUSB directory contains only RFXtrxUSB.ino

Open RFXtrxUSB.ino and click the Upload button. The USB firmware will be compiled and flashed in the RFX Wifi.

You can now use the USB port to communicate with RFXmngnr or RFXflash to the RFX433/868

7.5. Add Wifi option to the RFXusb-RFX433

Needs a very small solder iron and SMD solder experience with 0603 components!!
Warranty is lost with this installed!

Use 5V 1A adapter with Mini-B connector, OTB-R08-5010

Remove resistors R12, R13

Solder these SMD components on the RFXusb-RFX433 PCB:

ESP32 16Mb
100n 0603 C9, C15, C22
22uF 0603 C21
10K 0603 R11, R14, R21, R22
SS8050-G T1, T2
2 tactile switches
PTS815SJM250SMTR

Note: it is possible that some parts are already present.

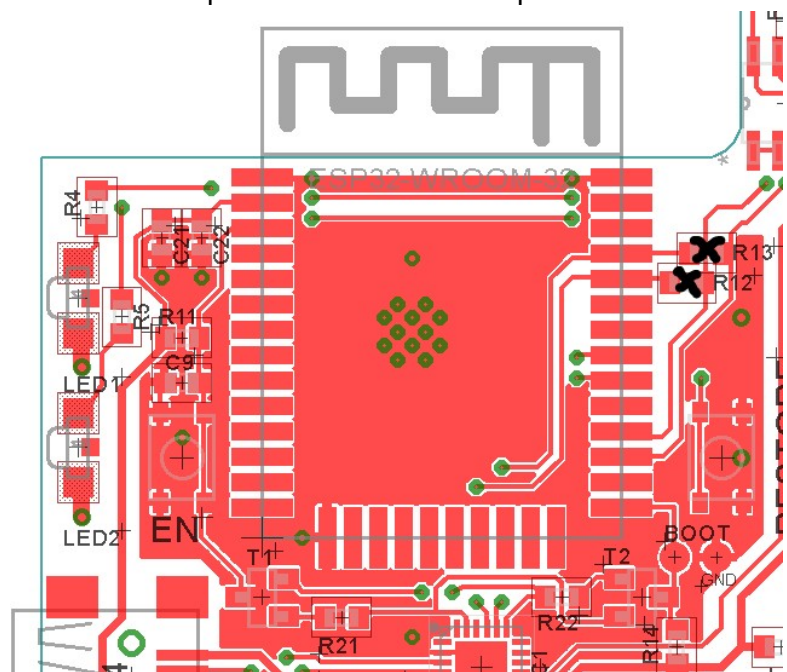

Flash the Wifi firmware in the ESP32.

7.6. Add the Wifi module to the RFX433XL-USB

Depending on the PCB revision:

Cut the wires at R6 and R8

Remove the resistors R6 and R8

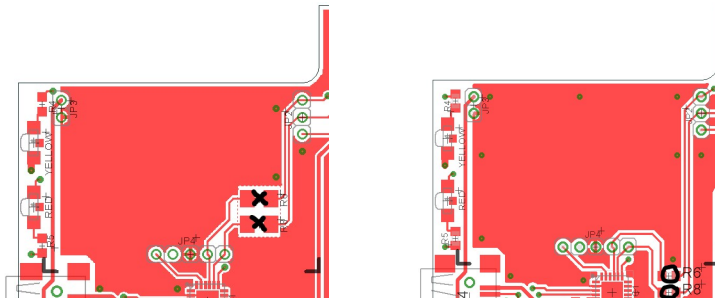

Press the push-to-fit connectors of the Wifi module into JP2-JP3-JP4

This needs some force! Use combination pliers and pinch right next to each connector if necessary. Press each connector into the PCB a little at a time.

8. RFXtrx433 special device codes

8.1. Remote commands

8.1.1. X10 RF Remote

Dec	Hex	Button
2	02	0
18	12	8
34	22	4
56	38	Rewind
58	3A	Info
64	40	CHAN+
66	42	2
82	52	Ent
96	60	VOL+
98	62	6
99	63	Stop
100	64	Pause
112	70	Cursor-left
113	71	Cursor-right
114	72	Cursor-up
115	73	Cursor-down
116	74	Cursor-up-left
117	75	Cursor-up-right
118	76	Cursor-down-right
119	77	Cursor-down-left
120	78	left mouse
121	79	left mouse-End
123	7B	Drag
124	7C	right mouse
125	7D	right mouse-End
130	82	1
146	92	9
160	A0	MUTE
162	A2	5
176	B0	Play
182	B6	Menu
184	B8	Fast Forward
186	BA	A+B
192	C0	CHAN-
194	C2	3
201	C9	Exit
209	D1	MP3
210	D2	DVD
211	D3	CD
212	D4	PC / Shift-4
213	D5	Shift-5
214	D6	Shift-Ent
215	D7	Shift-Teletext
216	D8	Text
217	D9	Shift-Text
224	E0	VOL-
226	E2	7
242	F2	Teletext
255	FF	Record

8.1.2. ATI Remote Wonder

Dec	Hex	Button	57	39	Full screen
0	00	A	58	3A	DVD Audio
1	01	B	112	70	Cursor-left
2	02	power	113	71	Cursor-right
3	03	TV	114	72	Cursor-up
4	04	DVD	115	73	Cursor-down
5	05	?	116	74	Cursor-up-left
6	06	Guide	117	75	Cursor-up-right
7	07	Drag	118	76	Cursor-down-right
8	08	VOL+	119	77	Cursor-down-left
9	09	VOL-	120	78	V
10	0A	MUTE	121	79	V-End
11	0B	CHAN+	124	7C	X
12	0C	CHAN-	125	7D	X-End
13	0D	1			
14	0E	2			
15	0F	3			
16	10	4			
17	11	5			
18	12	6			
19	13	7			
20	14	8			
21	15	9			
22	16	txt			
23	17	0			
24	18	snapshot ESC			
25	19	C			
26	1A	^			
27	1B	D			
28	1C	TV/RADIO			
29	1D	<			
30	1E	OK			
31	1F	>			
32	20	<-			
33	21	E			
34	22	v			
35	23	F			
36	24	Rewind			
37	25	Play			
38	26	Fast forward			
39	27	Record			
40	28	Stop			
41	29	Pause			
44	2C	TV			
45	2D	VCR			
46	2E	RADIO			
47	2F	TV Preview			
48	30	Channel list			
49	31	Video Desktop			
50	32	red			
51	33	green			
52	34	yellow			
53	35	blue			
54	36	rename TAB			
55	37	Acquire image			
56	38	edit image			

8.1.3. ATI Remote Wonder Plus

Dec	Hex	Button	Dec	Hex	Button
0	00	A	35	23	F
1	01	B	36	24	Rewind
2	02	power	37	25	Play
3	03	TV	38	26	Fast forward
4	04	DVD	39	27	Record
5	05	?	40	28	Stop
6	06	Guide	41	29	Pause
7	07	Drag	42	2A	TV2
8	08	VOL+	43	2B	Clock
9	09	VOL-	44	2C	TV
10	0A	MUTE	45	2D	VCR
11	0B	CHAN+	46	2E	RADIO
12	0C	CHAN-	47	2F	TV Preview
13	0D	1	48	30	Channel list
14	0E	2	49	31	Video Desktop
15	0F	3	50	32	red
16	10	4	51	33	green
17	11	5	52	34	yellow
18	12	6	53	35	blue
19	13	7	54	36	rename TAB
20	14	8	55	37	Acquire image
21	15	9	56	38	edit image
22	16	txt	57	39	Full screen
23	17	0	58	3A	DVD Audio
24	18	Open Setup Menu	112	70	Cursor-left
25	19	C	113	71	Cursor-right
26	1A	^	114	72	Cursor-up
27	1B	D	115	73	Cursor-down
28	1C	FM	116	74	Cursor-up-left
29	1D	<	117	75	Cursor-up-right
30	1E	OK	118	76	Cursor-down-right
31	1F	>	119	77	Cursor-down-left
32	20	Max/Restore Window	120	78	Left Mouse Button
33	21	E	121	79	V-End
34	22	v	124	7C	Right Mouse Button
			125	7D	X-End

8.1.4. Medion Remote

Dec	Hex	Button	55	37	Acquire image
0	00	Mute	56	38	edit image
1	01	B	57	39	Full screen
2	02	power	58	3A	DVD Audio
3	03	TV	112	70	Cursor-left
4	04	DVD	113	71	Cursor-right
5	05	Photo	114	72	Cursor-up
6	06	Music	115	73	Cursor-down
7	07	Drag	116	74	Cursor-up-left
8	08	VOL-	117	75	Cursor-up-right
9	09	VOL+	118	76	Cursor-down-right
10	0A	MUTE	119	77	Cursor-down-left
11	0B	CHAN+	120	78	V
12	0C	CHAN-	121	79	V-End
13	0D	1	124	7C	X
14	0E	2	125	7D	X-End
15	0F	3			
16	10	4			
17	11	5			
18	12	6			
19	13	7			
20	14	8			
21	15	9			
22	16	txt			
23	17	0			
24	18	snapshot ESC			
25	19	DVD MENU			
26	1A	^			
27	1B	Setup			
28	1C	TV/RADIO			
29	1D	<			
30	1E	OK			
31	1F	>			
32	20	<-			
33	21	E			
34	22	v			
35	23	F			
36	24	Rewind			
37	25	Play			
38	26	Fast forward			
39	27	Record			
40	28	Stop			
41	29	Pause			
44	2C	TV			
45	2D	VCR			
46	2E	RADIO			
47	2F	TV Preview			
48	30	Channel list			
49	31	Video Desktop			
50	32	red			
51	33	green			
52	34	yellow			
53	35	blue			
54	36	rename TAB			

8.2. Harrison address conversion to switch settings

The address used is converted to the address selected in the Harrison curtain motor using the table below.

switch	1	2	3	4		5	6	7	8
	H	H	H	H		X	X	X	X
A	0	1	1	0	1	0	0	0	0
B	0	1	1	1	2	0	0	0	1
C	0	1	0	0	3	0	0	1	0
D	0	1	0	1	4	0	0	1	1
E	1	0	0	0	5	0	1	0	0
F	1	0	0	1	6	0	1	0	1
G	1	0	1	0	7	0	1	1	0
H	1	0	1	1	8	0	1	1	1
I	1	1	1	0	9	1	0	0	0
J	1	1	1	1	10	1	0	0	1
K	1	1	0	0	11	1	0	1	0
L	1	1	0	1	12	1	0	1	1
M	0	0	0	0	13	1	1	0	0
N	0	0	0	1	14	1	1	0	1
O	0	0	1	0	15	1	1	1	0
P	0	0	1	1	16	1	1	1	1

H H H H = House code

X X X X = device code

Switch position in the motor:

Up = 1

Middle = not used!!!!

Down = 0

Examples:

If you assign the address E7 (1000 0110) to the curtain motor then set the switches to: 1=up, 2=down, 3=down, 4=down, 5=down, 6=up, 7=up, 8=down

If you assign the address A2 (0110 0001) to the curtain motor then set the switches to: 1=down, 2=up, 3=up, 4=down, 5=down, 6=down, 7=down, 8=up

8.3. Flamingo, AB400, IMPULS, Sartano, Brennenstuhl, SilverCrest 91089, Cranenbroek switch settings

Use type ELRO AB400D

Note that the HC (House Code A-P) is the house code used in programs and has no direct relation with the A,B,C,D,E buttons on the remotes!

	1	2	3	4						<==	switches	
HC=====												
A	0	0	0	0								
B	0	0	0	1								
C	0	0	1	0								
D	0	0	1	1								
E	0	1	0	0								
F	0	1	0	1								
G	0	1	1	0								
H	0	1	1	1								
I	1	0	0	0								
J	1	0	0	1								
K	1	0	1	0								
L	1	0	1	1								
M	1	1	0	0								
N	1	1	0	1								
O	1	1	1	0								
P	1	1	1	1								

	5	A	B	C	D	E						<==	switches	
	5	6	7	8	9	10	5	A	B	C	D	E	<==	OR switches
DC=====DC=====														
1	0	0	0	0	0	0	33	0	0	0	0	0	1	
2	0	0	0	1	0	0	34	0	0	0	1	0	1	
3	0	0	1	0	0	0	35	0	0	1	0	0	1	
4	0	0	1	1	0	0	36	0	0	1	1	0	1	
5	0	1	0	0	0	0	37	0	1	0	0	0	1	
6	0	1	0	1	0	0	38	0	1	0	1	0	1	
7	0	1	1	0	0	0	39	0	1	1	0	0	1	
8	0	1	1	1	0	0	40	0	1	1	1	0	1	
9	1	0	0	0	0	0	41	1	0	0	0	0	1	
10	1	0	0	1	0	0	42	1	0	0	1	0	1	
11	1	0	1	0	0	0	43	1	0	1	0	0	1	
12	1	0	1	1	0	0	44	1	0	1	1	0	1	
13	1	1	0	0	0	0	45	1	1	0	0	0	1	
14	1	1	0	1	0	0	46	1	1	0	1	0	1	
15	1	1	1	0	0	0	47	1	1	1	0	0	1	
16	1	1	1	1	0	0	48	1	1	1	1	0	1	
17	0	0	0	0	1	0	49	0	0	0	0	1	1	
18	0	0	0	1	1	0	50	0	0	0	1	1	1	
19	0	0	1	0	1	0	51	0	0	1	0	1	1	
20	0	0	1	1	1	0	52	0	0	1	1	1	1	
21	0	1	0	0	1	0	53	0	1	0	0	1	1	
22	0	1	0	1	1	0	54	0	1	0	1	1	1	
23	0	1	1	0	1	0	55	0	1	1	0	1	1	
24	0	1	1	1	1	0	56	0	1	1	1	1	1	
25	1	0	0	0	1	0	57	1	0	0	0	1	1	
26	1	0	0	1	1	0	58	1	0	0	1	1	1	
27	1	0	1	0	1	0	59	1	0	1	0	1	1	
28	1	0	1	1	1	0	60	1	0	1	1	1	1	
29	1	1	0	0	1	0	61	1	1	0	0	1	1	
30	1	1	0	1	1	0	62	1	1	0	1	1	1	
31	1	1	1	0	1	0	63	1	1	1	0	1	1	
32	1	1	1	1	1	0	64	1	1	1	1	1	1	

Examples:

```
A1    0000000000
A15   0000111000
N2    1101000100
N11   1101101000
```

0 = switch off
1 = switch on

8.4. Energenie 5-gang 429.950

To know the codes to use open the remote and check the 1 to 5 jumpers connected. If a jumper connection is open it is a 1. If connected it is a 0 (zero)

	1	2	3	4	jumper setting in the remote
HC=====					
A	0	0	0	0	
B	0	0	0	1	
C	0	0	1	0	
D	0	0	1	1	
E	0	1	0	0	
F	0	1	0	1	
G	0	1	1	0	
H	0	1	1	1	
I	1	0	0	0	
J	1	0	0	1	
K	1	0	1	0	
L	1	0	1	1	
M	1	1	0	0	
N	1	1	0	1	
O	1	1	1	0	
P	1	1	1	1	

If jumper 5 is open (1) than add 5 to the remote code.

Examples:

Jumper	Button Code	
1 2 3 4 5		
1 0 0 0 0	1	I1
1 0 0 0 1	1	I6

8.5. Phenix, IDK YC-4000S switch settings

Use type ELRO AB400D

Note that the HC (House Code A-P) is the house code used in programs and has no direct relation with the A,B,C,D,E buttons on the remotes!

```
HC  switch
   1 2 3 4
=====
A   0 0 0 0
B   0 0 0 1
C   0 0 1 0
D   0 0 1 1
E   0 1 0 0
F   0 1 0 1
G   0 1 1 0
H   0 1 1 1
I   1 0 0 0
J   1 0 0 1
K   1 0 1 0
L   1 0 1 1
M   1 1 0 0
N   1 1 0 1
O   1 1 1 0
P   1 1 1 1
```

```
DC  switch
   5 A B C D
=====
1   0 0 0 0 0
2   0 0 0 1 0
3   0 0 1 0 0
4   0 0 1 1 0
5   0 1 0 0 0
6   0 1 0 1 0
7   0 1 1 0 0
8   0 1 1 1 0
9   1 0 0 0 0
10  1 0 0 1 0
11  1 0 1 0 0
12  1 0 1 1 0
13  1 1 0 0 0
14  1 1 0 1 0
15  1 1 1 0 0
16  1 1 1 1 0
17  0 0 0 0 1
18  0 0 0 1 1
19  0 0 1 0 1
20  0 0 1 1 1
21  0 1 0 0 1
22  0 1 0 1 1
23  0 1 1 0 1
24  0 1 1 1 1
25  1 0 0 0 1
26  1 0 0 1 1
27  1 0 1 0 1
28  1 0 1 1 1
29  1 1 0 0 1
30  1 1 0 1 1
31  1 1 1 0 1
32  1 1 1 1 1
```

8.6. HE105 switch settings

Unitnr	HE105 switches				
	1	2	3	4	5
0	0	0	0	0	0
1	0	0	0	0	1
2	0	0	0	1	0
3	0	0	0	1	1
4	0	0	1	0	0
5	0	0	1	0	1
6	0	0	1	1	0
7	0	0	1	1	1
8	0	1	0	0	0
9	0	1	0	0	1
10	0	1	0	1	0
11	0	1	0	1	1
12	0	1	1	0	0
13	0	1	1	0	1
14	0	1	1	1	0
15	0	1	1	1	1
16	1	0	0	0	0
17	1	0	0	0	1
18	1	0	0	1	0
19	1	0	0	1	1
20	1	0	1	0	0
21	1	0	1	0	1
22	1	0	1	1	0
23	1	0	1	1	1
24	1	1	0	0	0
25	1	1	0	0	1
26	1	1	0	1	0
27	1	1	0	1	1
28	1	1	1	0	0
29	1	1	1	0	1
30	1	1	1	1	0
31	1	1	1	1	1

8.7. HQ COCO-20

Note that the HC (House Code A-P) is the house code used in programs and has no direct relation with the A,B,C,D,E buttons on the remotes!

6 7 8 9 <== switches in module

HC=====

```
A 0 0 0 0
B 0 0 0 1
C 0 0 1 0
D 0 0 1 1
E 0 1 0 0
F 0 1 0 1
G 0 1 1 0
H 0 1 1 1
I 1 0 0 0
J 1 0 0 1
K 1 0 1 0
L 1 0 1 1
M 1 1 0 0
N 1 1 0 1
O 1 1 1 0
P 1 1 1 1
```

10 1 2 3 4 5

10 1 2 3 4 5 <== switches in module

DC=====DC=====

```
1 0 0 0 0 0 0 33 1 0 0 0 0 0
2 0 0 0 0 0 1 34 1 0 0 0 0 1
3 0 0 0 0 1 0 35 1 0 0 0 1 0
4 0 0 0 0 1 1 36 1 0 0 0 1 1
5 0 0 0 1 0 0 37 1 0 0 1 0 0
6 0 0 0 1 0 1 38 1 0 0 1 0 1
7 0 0 0 1 1 0 39 1 0 0 1 1 0
8 0 0 0 1 1 1 40 1 0 0 1 1 1
9 0 0 1 0 0 0 41 1 0 1 0 0 0
10 0 0 1 0 0 1 42 1 0 1 0 0 1
11 0 0 1 0 1 0 43 1 0 1 0 1 0
12 0 0 1 0 1 1 44 1 0 1 0 1 1
13 0 0 1 1 0 0 45 1 0 1 1 0 0
14 0 0 1 1 0 1 46 1 0 1 1 0 1
15 0 0 1 1 1 0 47 1 0 1 1 1 0
16 0 0 1 1 1 1 48 1 0 1 1 1 1
17 0 1 0 0 0 0 49 1 1 0 0 0 0
18 0 1 0 0 0 1 50 1 1 0 0 0 1
19 0 1 0 0 1 0 51 1 1 0 0 1 0
20 0 1 0 0 1 1 52 1 1 0 0 1 1
21 0 1 0 1 0 0 53 1 1 0 1 0 0
22 0 1 0 1 0 1 54 1 1 0 1 0 1
23 0 1 0 1 1 0 55 1 1 0 1 1 0
24 0 1 0 1 1 1 56 1 1 0 1 1 1
25 0 1 1 0 0 0 57 1 1 1 0 0 0
26 0 1 1 0 0 1 58 1 1 1 0 0 1
27 0 1 1 0 1 0 59 1 1 1 0 1 0
28 0 1 1 0 1 1 60 1 1 1 0 1 1
29 0 1 1 1 0 0 61 1 1 1 1 0 0
30 0 1 1 1 0 1 62 1 1 1 1 0 1
31 0 1 1 1 1 0 63 1 1 1 1 1 0
32 0 1 1 1 1 1 64 1 1 1 1 1 1
```

Examples:

Switch 6 7 8 9 0 1 2 3 4 5

```
=====
A1 0 0 0 0 0 0 0 0 0
A15 0 0 0 0 1 1 1 0 0 0
N2 1 1 0 1 0 0 0 1 0 0
N11 1 1 0 1 1 0 1 0 0 0
```

0 = switch off

1 = switch on

8.8. MDREMOTE V106, V107

This MDREMOTE has been tested.

<http://www.ultraleds.co.uk/mini-dimmer-with-rf-remote-control-12-or-24v-dc-12a-maximum.html>

The RFXtrx433 can only transmit MDREMOTE commands.

Procedure to find the ID of the MDREMOTE: In RFXmngnr enable the X10 protocol and enable "Undec on". Press a button on the MDREMOTE remote.

The undecoded message contains the ID in the 2nd and 3rd byte, for example:

UNDECODED NEC:20AF6801D1

The 2 bytes after 20 is the MDREMOTE ID, in this example AF 68

8.9. MDREMOTE V108, EKAB-10KRF

This MDREMOTE has been tested.

- <http://www.ledstripkoning.nl/accessoires/dimmers-wit/draadloze-dimmer-10-knops-rf/>

Procedure to find the ID of the MDREMOTE: In RFXmngnr enable the Lighting4 protocol and enable "Undec on". Press a button on the MDREMOTE remote.

The undecoded message contains the ID in the 2nd and 3rd byte, for example:

UNDECODED ARC:201A0703FCFC

The 2 bytes after 20 is the MDREMOTE ID, in this example 1A 07

8.10. Aoke relay

The Aoke 12V DC - 315MHz or 433.92MHz 1 channel relay is available at www.aliexpress.com store No.110758. Indicate clearly the required frequency when ordering!

The 1 channel learning relays can be used, see the picture below.

For example, for 1 relay:

http://www.aliexpress.com/store/product/DC12V-1CH-wireless-switch-remote-control-system-remote-control-switch-for-guard-door-window-curtain/110758_936534863.html

or for 6 relays:

http://www.aliexpress.com/store/product/ak-DC12V-1CH-RF-rocker-switch-livolo-switch-system-in-china-j-12a-108d-smart-house/110758_1007306574.html



The jumper next to the learning button defines to operating mode:
Open = momentary
1-2 = toggle mode
2-3 = on/off mode (to be used with the RFXtrx)

8.11. SEAV TXS4

The ID can be found using RFXmngnr and enable only ByronSX and undec on.

Or calculate the ID:

A SW1 switch on = 1

```
|-----SW1-----|
 1 2 3   4 5 6 7   8 9 10
0 x x x | x x x x | x x x 0 | 0 1 0 1
```

For example SW1 = **on off on off on off on off on off**

The ID will become:

```
|-----SW1-----|
 1 2 3   4 5 6 7   8 9 10
0 1 0 1 | 0 1 0 1 | 0 1 0 0 0 | 0 1 0 1 this is hex: 5 5 4 5
```

8.12. How to find the dx.com RGB LED strip driver ID

Valid for the TRC02 remote with 2 batteries.

Flash the RFXtrx433 with Type2 firmware to be able to receive the remote ID in RFXmngnr. In RFXmngnr enable only the LightwaveRF (AD) protocol.

```
-----
Packettype    = Lighting5
subtype       = RGB TRC02
Sequence nbr  = 5
ID          = FCC48B
Command       = On
Signal level  = 8
```

The ID is: **FC C4 8B**

If necessary flash the RFXtrx433 back to Type1 or ext if Type2 does not support devices you need. (See chapter 2.2)

8.13. How to find the dx.com RGB LED strip driver ID (rev. 2)

Valid for the TRC02 remote with 3 batteries and ebay.com 191481664563.

In RFXmngnr enable only the Lighting4 protocol.

```
-----
Packettype    = Lighting4
subtype       = PT2262
Sequence nbr  = 29
Code          = 161C84
```

The ID is: **16 1C**

8.14. How to find the Eurodomest ID

You can assign a random ID to the Eurodomest. If you want to use the same ID as the remote you can find the ID of the remote using RFXmngnr.

Start RFXmngnr and enable only the Lighting4 protocol.

Press a button on the remote and you will receive a message like:

```
-----
Packettype    = Lighting4
subtype       = PT2262
Sequence nbr  = 12
Code          = 6DFE0F
```

The ID is: **6 DF E0**

Note: Eurodomest can also be controlled using ARC.

8.15. How to find the Screenline ID

You can assign a random ID to the Screenline. If you want to use the same ID as the remote you can find the ID of the remote using RFXmng. Start RFXmng and enable only the Lighting4 protocol and undec on. Press a button on the remote and you will receive a message like:

```
-----  
Packettype = UNDECODED RF Message  
UNDECODED ARC:4000F7BD1D2AF04B7
```

The ID starts at the 7th character, in this example the ID = **7B D1**

8.16. How to find the Avantek remote ID

You can find the ID of the remote using RFXmng. Start RFXmng and enable only the Lighting4 protocol. Press a button on the remote and you will receive a message like:

```
Packettype = Lighting4  
subtype = PT2262  
Sequence nbr = 3  
Code = 122336 decimal:1188662  
S1- S24 = 0001 0010 0010 0011 0011 0110  
Pulse = 280 usec  
Signal level = 7 -64dBm
```

The ID to be used is **1 22 33**

8.17. How to find the Siemens SF01 ID

Start RFXmng and enable only undec on. Press a button on the remote and you will receive a message like:

```
-----  
11-04-2023 11:08:56:552=  
507F000001014802F8013002EC012E02EF012A02ED012D02F1012902EF012A01A9027002ED012D01A8027401A1027801A30  
27602ED012C02F2012802EF012B01A1027702EA013002F3012B01A702710000  
Packettype = RAW Packet  
Packet Length = 80  
subtype = RAW packet  
Sequence nbr = 0  
Repeat = 1  
Nbr of pulses = 19  
328 760 304 748 302 751 298 749 301 753 297 751 298 425 624 749 301 424 628 417  
632 419 630 749 300 754 296 751 299 417 631 746 304 755 299 423 625 0
```

A short-long pulse time is a "1" and long-short is a "0", thus:

```
328 760 304 748 302 751 298 749 301 753 297 751 298 425 624 749  
1 1 1 1 1 1 1 1 1 1 1 1 0  
  
301 424 628 417 632 419 630 749 300 754 296 751 299 417 631 746  
1 0 0 0 1 1 1 0  
  
304 755 299 423 625 0  
1 1 0
```

The ID is in the first 16 bits. 1111 1110 1000 1110
Convert binary to hex and you find the ID: FE 8E

9. Blyss commands

Some Blyss devices, like the Blyss motors, require a special command sequence number. To simplify it; 0,1,2,3,4,0,1,...

This sequence number is normally created by the Blyss remote but now also by the RFXtrx433.

If you use a Blyss remote and the application (Domoticz, DomotiGa, Homeseer...) does not sync with the received Blyss command you will see that you need to send multiple commands with the RFXtrx433 before the Blyss device will respond.

For example,

The Blyss remote transmits with the sequence numbers 0,1,2

If the RFXtrx433 transmits now with sequence number 0 it will not be seen by the Blyss device as a valid command and at the time the RFXtrx433 transmits the commands 1,2,3 the command will be detected as valid when it receives the command with sequence number 3.

The same is true for the remote. If you transmit commands with the RFXtrx433 and after that with a Blyss remote you need to transmit several commands with the remote before the Blyss device responds.

I guess the same behaviour will show if you use multiple Blyss remotes.

10. Somfy RTS

Somfy RTS* devices can only be controlled by the RFXtrx433E, RFXtrx433XL, RFX433. (Not by the RFXtrx433)

The RFXtrx433E, RFXtrx433XL, RFX433 version is an RFXtrx433 with additional hardware to enable the RFY protocol used to control Somfy RTS.

The 433.42MHz transmitter in the RFXtrx433E/RFXtrx433XL/RFX433 is used for a reliable control of the Somfy RTS devices over a large distance and through walls.

The RFXtrx433E, RFXtrx433XL, RFX433 433.92MHz transmitter is also used to control all other devices.

To pair the Somfy RTS device:

- Select a unique ID and unitcode for the RFXCOM RFY device.
- Disconnect power from all Somfy RTS devices except the device to pair. (not necessary if you select the correct device on the Somfy remote)
- Press the Program button > 2 seconds on the original Somfy remote until the Somfy device responds.
- Transmit a Program command with the RFXtrx433E, RFXtrx433XL., RFX433 The Somfy RTS device should respond indicating the pair command was successful.

The RFXCOM RFY remote is registered in the RFXtrx433E, RFXtrx433XL, RFX433 by sending a Program command.

Up to 40 RFXCOM RFY remotes can be registered in the RFXtrx433E, RFXtrx433XL, RFX433. Remotes can be erased from the RFXtrx433E, RFXtrx433XL, RFX433 using the RFXmngpr program.

The Somfy RTS device can be controlled by any application if the same ID and Unit Code are used.

For example, if the RTS device is paired using RFXmngpr with ID=1 02 03 and Unit Code 1, the RTS device can be controlled with Homeseer using the same ID and unit code.

Usage:

To control Somfy Centralis modules use the RFY2 = > 2 seconds commands.

Somfy Tilt motors can be configured in 2 modes, US or European.

To toggle between modes, press the Reset/ Prog button 2 s. Repeat until the LED, according to the desired configuration, lights up. Store by pressing 2 s.

To control Venetian Blinds in US mode:

- up/down (transmit < 0.5 seconds): open or close
- up/down (transmit > 2seconds): change angle

To control Venetian Blinds in Europe mode:

- up/down (transmit < 0.5 seconds): change angle
- up/down (transmit > 2seconds): open or close

Somfy RTS motors have a limited number of memory locations for the remotes. Some have a max of 10 remotes. If you try to pair the 11th remote (can be a RFXtrx433E, RFXtrx433XL, RFX433 ID-unit) the motor reacts as if the pairing was successful but there is no response on an up/down command.

To solve this, reset the motor to remove all remotes.

* Somfy RTS are registered trademarks of Somfy System, Inc.

10.1. How to move RFY devices to another RFXtrx433E, RFXtrx433XL or RFX433

Important:

1. If an RFY devices is moved to another RFXtrx do not use the old RFXtrx to control the RFY devices, because the rolling code will become out of sync with the Somfy device.
2. Use the latest RFXmngnr and for the RFXtrx433E the latest Pro1 or Pro2 firmware and for the RFXtrx433XL the latest ProXL1 firmware and for the RFX433 the latest RFX433 FW

Step 1: List all RFY devices in the “old” RFXtrx.

The screenshot shows the RFXmngnr software interface. The 'Type' is set to 'RFY' and the 'Command' is 'List remotes'. The 'ID' is 0, 'Unit Code' is 1, and 'rfu1', 'rfu2', and 'rfu3' are all set to 00. The 'Transmit' button is highlighted. The output window shows the following log:

```

=====
02-Dec-18 03:13:53:971= RFY command
=====
Packettype = RFY
subtype = RFY
Sequence nbr = 18
idl-3 = 000000 decimal:0
Unit = 1
Command = List remotes
rfu1 = 00
rfu2 = 00
rfu3 = 00
Signal level = +10 dBm
-----
02-Dec-18 03:13:54:284
Packettype = Interface Message
subtype = RFY remote:0 ID:00 00 01 unitnbr:1 rfu1:A4 rfu2:0 rfu3:14
  
```

Step 2: Connect the “new” RFXtrx433E, RFXtrx433XL or RFX433.

Select the ID, Unit Code, rfu1, rfu2 and rfu3 values.

Transmit a Program command. The values are now programmed in the “new” RFXtrx and the Somfy device can be controlled with this RFXtrx.

Transmit an Up and Down command to be sure the motor is no longer in program mode!

The screenshot shows the RFXmngnr software interface. The 'Type' is set to 'RFY' and the 'Command' is 'Program'. The 'ID' is 0, 'Unit Code' is 1, and 'rfu1' is set to 'A4'. The 'Transmit' button is highlighted. The output window shows the following log:

```

=====
02-Dec-18 03:13:53:971= RFY command
=====
Packettype = RFY
subtype = RFY
Sequence nbr = 18
idl-3 = 000000 decimal:0
Unit = 1
Command = List remotes
rfu1 = 00
rfu2 = 00
rfu3 = 00
Signal level = +10 dBm
-----
02-Dec-18 03:13:54:284
Packettype = Interface Message
subtype = RFY remote:0 ID:00 00 01 unitnbr:1 rfu1:A4 rfu2:0 rfu3:14
  
```

11. Dooya and compatibles

11.1. BlindsT6

To add a RFXtrx433/E/XL, RFX433 BlindsT6 device to the blinds motor:

1. press the "program" button twice on the original remote ==> 2 beeps
2. transmit the "confirm" command with the RFXtrx ==> 5 beeps

11.1.1. Dooya DT52E, DT82TV, DT82TN

- Select a random ID different from all zeroes and a unit code 1 to 15
- Press the program button on the motor until the LED lights up
- Transmit a Confirm command.
- The LED on the motor starts blinking.
- Transmit again a Confirm command.
- The LED on the motor blinks 5 times
- The motor can be controlled now by the RFXtrx433/E/XL, RFX433

11.2. Bi-directional DD27xx

For Home Assistant use BlindsT21 to control bi-directional motors.

To add a RFX-433EMC DD27xx bi-directional device to the blinds motor:

1. Set the upper and lower limits in the motor using the original remote.
2. press the "P2" button twice on the original remote.
3. transmit the "P2 (pair)" command with the RFX-433EMC

The hex command structure that can be used for DD27xx

```

0C 31 00 00 11 22 33 44 00 00 00 00 00
| | | | | | | | | | | | |
| | | | | | | | | | | | = always 00
| | | | | | | | | | | | ==== angle can be hex 00 to B4
| | | | | | | | | | | | ===== percent can be hex 00 to 64
| | | | | | | | | | | | ===== command
| | | | | | | | | | | | ===== unit code 00 to 10
| | | | | | | | | | | | ===== ID4 00 to FF (ID 00000001 to FFFFFFFF)
| | | | | | | | | | | | ===== ID3 00 to FF
| | | | | | | | | | | | ===== ID2 00 to FF
| | | | | | | | | | | | ===== ID1 00 to FF
| | | | | | | | | | | | ===== always 00
| | | | | | | | | | | | ===== always 00
| | | | | | | | | | | | ===== always 31
| | | | | | | | | | | | ===== always 0C
=====

```

Command:

Up	0x00
Down	0x01
Stop	0x02
P2 (pair)	0x03
Percent	0x04
Angle	0x05
Percent+Angle	0x06

Unit code:

00 unit 1
01 02 03 04 05 06 07 08 09 0A 0B 0C 0D 0E
0F unit 16
10 Group command, all units with the same ID.

Example, ID 11 22 33 44, unit 1, P2 (pair) command.

The hex command line without spaces to be used is:

```
0C310000112233440003000000
```

12. Cherubini

You can't use the ID of the Cherubini remote because the Cherubini protocol is using a rolling code.

First you must pair the RFX-433EMC with each motor, as an additional remote, using a unique ID for each motor.

For example:

motor 1: ID 10 30 01

motor 2: ID 10 30 02

motor 3: ID 10 30 03

Pairing must be done using RFXmngn on a Windows system.

Set the motor in pairing mode (see the Cherubini user guide)

Transmit the Program command.

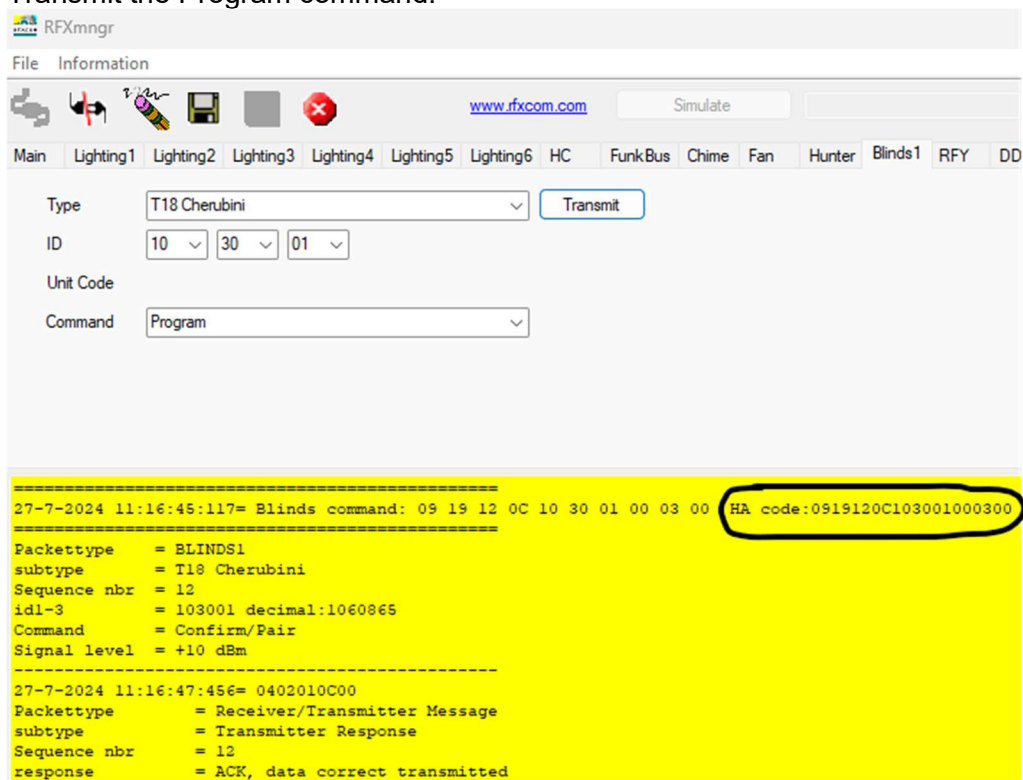

To configure this motor in Home Assistant use the command: 0919120C103001000300.

Open the RFXCOM integration, click CONFIGURE and add the device:

Rfxtrx Options ? ×

Enable automatic add

Protocols
ac, arc, blindst1234, fineoffset, hideki, lacrosse, O...

Enter event code to add
0919120C103001000300

Select device to configure

SUBMIT

13. ID switches Casafan and Lucci Air fans

Select the ID for switch settings:

ID	Remote switches			
	1	2	3	4
0	0	0	0	0
1	0	0	0	1
2	0	0	1	0
3	0	0	1	1
4	0	1	0	0
5	0	1	0	1
6	0	1	1	0
7	0	1	1	1
8	1	0	0	0
9	1	0	0	1
A	1	0	1	0
B	1	0	1	1
C	1	1	0	0
D	1	1	0	1
E	1	1	1	0
F	1	1	1	1

For LucciAir AC fan: 0 = ON

For Casafan and LucciAir DC fan: 1 = ON

14. Transmit Funkbus (Insta, Gira, Jung, Berker)

With Pro2 or ProXL1 firmware you can transmit Funkbus commands using ID : 3F CC.

If the Home Automation application has Funkbus control not implemented, you can use an ANSLUT device instead.

The 1st digit of the ID indicates the Group.

0 = A,

1 = B,

2 = C,

3 = Scenes

The last 2 bytes are the remote ID: 3F CC.

For de groups A, B en C: Unit code 1-8 = channel 1-8

For group Scenes (3) : Unit code 1-5 = scene 1-5.

Example Group A - Channel 1 - On

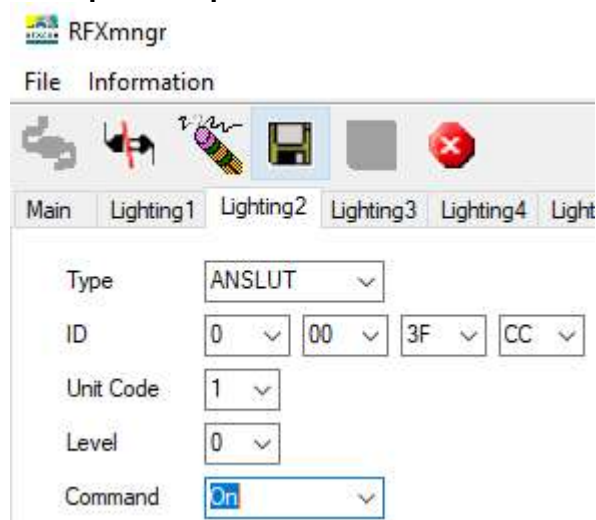

The screenshot shows the RFXmngnr software interface. The title bar reads 'RFXmngnr'. Below the title bar is a menu bar with 'File' and 'Information'. A toolbar contains icons for a mouse, a hand, a pencil, a floppy disk, a grey square, and a red 'X'. Below the toolbar is a tabbed interface with tabs for 'Main', 'Lighting1', 'Lighting2', 'Lighting3', 'Lighting4', and 'Lighting5'. The 'Main' tab is active. The configuration fields are as follows:

Type	ANSLUT			
ID	0	00	3F	CC
Unit Code	1			
Level	0			
Command	On			

Example Group Scenes – Scene 5 - On

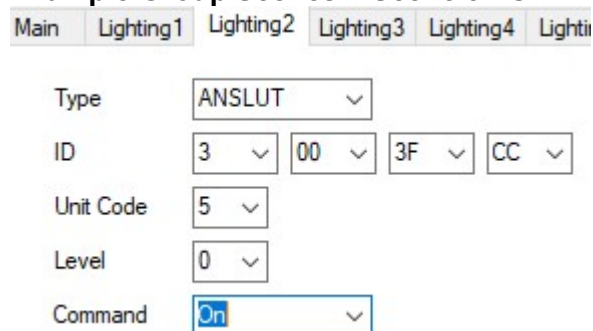

The screenshot shows the RFXmngnr software interface with the 'Lighting2' tab active. The configuration fields are as follows:

Type	ANSLUT			
ID	3	00	3F	CC
Unit Code	5			
Level	0			
Command	On			

15. Transmit undecoded ARC commands.

Plug-in modules or other equipment with a PT2262 can be controlled using Lighting4. There are a lot of brands using the PT2262 and some of them use the same timing (350) as used by the ARC devices but a different protocol definition.

Messages will be received as undecoded ARC messages if the protocol definition does not match the definition of the ARC protocol. Remote commands are received as ARC commands with a wrong house and device code and/or command code or as undecoded ARC messages if "undec on" is enabled. Decoding of these remotes is therefore not possible because they overlap the ARC protocol partly.

But transmitting these commands is possible using the Lighting4 command.

So if we receive this command UNDECODED ARC:18014403:
(18 is not used)

hex to binary table

```

0=0 0 0 0
1=0 0 0 1
2=0 0 1 0
3=0 0 1 1
4=0 1 0 0
5=0 1 0 1
6=0 1 1 0
7=0 1 1 1
8=1 0 0 0
9=1 0 0 1
A=1 0 1 0
B=1 0 1 1
C=1 1 0 0
D=1 1 0 1
E=1 1 1 0
F=1 1 1 1
    
```

0 1 4 4 0 3 = selection box 0000 0001 0100 0100 0000 0011
Not selected = 0, box selected = 1

And the Lighting4 command contains the same "undec code" 01 44 03:
Lighting4 command:09 13 00 04 **01 44 03** 01 5E 00
pulse timing is 350 = hex 015E

Another example:

For this command UNDECODED ARC:18014430 set on the Lighting4 tab in RFXmng selection box 1 to 24 to 0 1 4 4 3 0 = 0000 0001 0100 0100 0011 0000

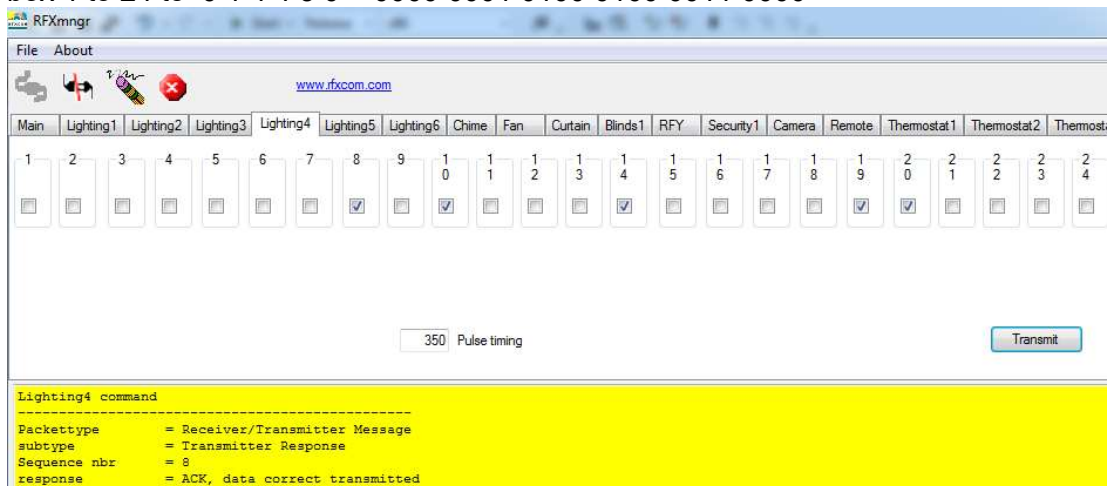

16. MCZ pellet stove.

RFXtrx433/RFXtrx433E:

In the Type2 firmware zip file which is available on the downloads page you will find a special firmware RFXtrxMCZ.hex that enables you to know the ID of the your MCZ remote. Flash the RFXtrxMCZ.hex firmware in your RFXtrx433/E/XL and start RFXmngr.

RFXtrx433XL, RFX433:

In RFXmngr select Receiver Freq 434.50 and enable MCZ

Transmit a command with the MCZ remote and you will receive the information.

The ID in this example is 81 3F 22

```
Packettype = Thermostat4
subtype    = MCZ pellet stove 2 fans model
Sequence nbr = 0
ID         = 0x813F22 decimal:8470306
Beep       = Yes
Fan1 speed = 1
Fan2 speed = 7
Flame power = 1
Command    = Off
Signal level = 6 -72dBm
```

Flash now Type2 or Ext firmware in your RFXtrx433/RFXtrx433E and you can control your MCZ stove using the received ID.

Important: remove the batteries from the original remote before you start using the RFXtrx433/E/XL, RFX433 to control the MCZ stove!

17. Lighting4 devices

17.1. Proluxx projection screen

Use Lighting4 with a pulse timing of 360

```
UP      1110 1101 0101 1001 0101 0010      ED 59 52
STOP    1110 1101 0101 1001 0101 1000      ED 59 58
DOWN    1110 1101 0101 1001 0101 0100      ED 59 54
RESET   1110 1101 0101 1001 0101 0001      ED 59 51
```

17.2. Kingpin (KP100) projection screen

Use Lighting4 with a pulse timing of 1040

```
UP          1110 0001 0100 0010 0010 0010      E1 42 22
STOP        1110 0001 0100 0010 0010 0100      E1 42 24
DOWN        1110 0001 0100 0010 0010 1000      E1 42 28
PROGRAM     1110 0001 0100 0010 0010 0001      E1 42 21
```

17.3. Mercury remote control mains sockets

<http://mercury.avsl.com/product?range=ME5124>

Use Lighting4 with a pulse timing of 188

```
1 OFF  010001000010101010011 1100
1 ON    010001000010101010011 0011

2 OFF  010001000010101011100 1100
2 ON    010001000010101011100 0011

3 OFF  010001000010101110000 1100
3 ON    010001000010101110000 0011

4 OFF  010001000010111010000 1100
4 ON    010001000010111010000 0011

5 OFF  010001000011101010000 1100
5 ON    010001000011101010000 0011
```

17.4. Conrad 034911 sockets

<http://www.conrad.nl/ce/nl/product/034911/Draadloze-schakelaarset-5-delig>

Use Lighting4 with a pulse timing of 425

Off = last 2 digits: 00

ON = last 2 digits: 01

```
Group  Unit
I      1 OFF  00 01 01 01 00 01 01 01 01 01 01 00
II     1 OFF  01 00 01 01 00 01 01 01 01 01 01 00
III    1 OFF  01 01 00 01 00 01 01 01 01 01 01 00
IV     1 OFF  01 01 01 00 00 01 01 01 01 01 01 00

I      1 OFF  00 01 01 01 00 01 01 01 01 01 01 00
I      2 OFF  00 01 01 01 01 01 00 01 01 01 01 00
I      3 OFF  00 01 01 01 01 01 01 00 01 01 01 00
I      4 OFF  00 01 01 01 01 01 01 01 00 01 01 00

I      1 OFF  00 01 01 01 00 01 01 01 01 01 01 00
I      1 ON   00 01 01 01 00 01 01 01 01 01 01 01
```

17.5. Sonoff

All Sonoff 433MHz RF receiver devices can be controlled by the RFXtrx433/E/XL using Lighting4 with a pulse timing of 370usec.

The 4 button Sonoff Lighting4 remote code:

The last digit indicates the button:

A	0001	hex 1
B	0010	hex 2
C	0100	hex 4
D	1000	hex 8

The first 5 digits are the ID. Here an example of ID=D216B button=A

Packettype = Lighting4
subtype = PT2262
Sequence nbr = 1
Code = D216B1 decimal:13768369
S1- S24 = 1101 0010 0001 0110 1011 0001
Pulse = 370 usec
Signal level = 8 -56dBm



The Lighting4 commands can be used for example to control the 4 relays in a Sonoff 4CH Pro https://www.banggood.com/SONOFF-4CH-Pro-10A-2200W-2_4Ghz-433MHz-RF-InchingSelf-LockingInterlock-Smart-Home-p-1153324.html

17.6. PT2262 and EV1527 oscillator resistors accepted

For the PT2262 use a 3M3 oscillator resistor

For the EV1527 a 220K, 270K or 390K oscillator resistor can be used.

18. Receive and Transmit RAW data

The Pro firmware can receive and transmit RAW data. This can be used to replay received data received from a remote. Note that this can only be used for a protocol with fixed code and rolling code cannot be used.

It is unknown if and how this is implemented in Home Automation applications!

Here an example of a packet received from an ARC remote in RFXmnr:

```
RAW Packet:
687F000001010804720132046701340467041401BB01300474013104680131046E0131046D0131047001330470012D046B0
133046C013004720132046E013104690132046A0133046D0138046C0130046A041401B901310471041701B70133046A0133
046F012E0000
Packettype      = RAW Packet
Packet Length  = 104
subtype        = RAW packet
Sequence nbr   = 0
Repeat         = 1
Nbr of pulses  = 25
264 1138 306 1127 308 1127 1044 443 304 1140 305 1128 305 1134 305 1133 305 1136
307 1136 301 1131 307 1132 304 1138 306 1134 305 1129 306 1130 307 1133 312 1132
304 1130 1044 441 305 1137 1047 439 307 1130 307 1135 302 0
```

The last value of zero indicates a gap timeout and the real gap is greater than 8000. To replay this packet replace the last zero with a value greater than 8000.

To replay this in RFXmnr, create a text file with the content below and send it on the RAW transmit tab.

The first value is 0 which indicates it is a single packet

The next value (7 in this example) is the repeat count.

Do not set the repeat count too high to lower the risk to disturb other RF transmissions.

```
0
7
264
1138
306
1127
308
1127
1044
443
304
1140
305
1128
305
1134
305
1133
305
1136
```

the next values

```
307
1135
302
10000
```

If you receive multiple RAW packet with more than 62 pulses, try to find the gap. This is normally a higher value and smaller than 8000. Here an example with a gap value of 6600 and the next 6596.

RAW Packet:

```
FC7F00000001190491012C0491012A0492012A0490012A049201270493012801B7040601BC03FF01B903FF048F012C04930
1270493012801B9040001BB03FF01BC040101BB03FF01BB040019C8013C049301280491012A049201290492012704940127
0494012701BE040201BA03FF01BD03FE0492012A049201290492012901BB03FF01BC03FF01BB040401BB03FF01BD040019C
401400490012B048F012D048F012A04950127049301270494012701BC040201BD03FF01BA03FF0493012804920128049501
2601BB040001BC040001B8040601B903FF01BC03FF19C801400492012A049301280492012A0495012704940128049501280
1BA040501BD
```

```
Packettype = RAW Packet
Packet Length = 252
subtype = RAW packet
Sequence nbr = 0
Repeat = 0
Nbr of pulses = 62
```

```
281 1169 300 1169 298 1170 298 1168 298 1170 295 1171 296 439 1030 444 1023 441
1023 1167 300 1171 295 1171 296 441 1024 443 1023 444 1025 443 1023 443 1024 6600
316 1171 296 1169 298 1170 297 1170 295 1172 295 1172 295 446 1026 442 1023 445
1022 1170 298 1170 297 1170 297 443 1023 444 1023 443 1028 443 1023 445 1024 6596
320 1168 299 1167 301 1167 298 1173 295 1171 295 1172 295 444 1026 445 1023 442
1023 1171 296 1170 296 1173 294 443 1024 444 1024 440 1030 441 1023 444 1023 6600
320 1170 298 1171 296 1170 298 1173 295 1172 296 1173 296 442 1029 445
```

Create a text file to control this device in RFXmngr:

```
0
7
281
1169
300
1169
298
1170
298
1168
298
1170
295
1171
296
439
1030
444
1023
441
1023
1167
300
1171
295
1171
296
441
1024
443
1023
444
1025
443
1023
443
1023
443
1024
6600
```

19. RFXtrx433XL/RFX433 - P1 smart meter connection

The RFXtrx433XL can be connected to the Dutch P1 smart meter with the DSMR P1 option board with RJ11 cable or DIY connection. The RFX433 can be connected using a RJ25

The connection can be tested in RFXmnggr.

Select the correct parameters and click Set Async port.

Important: the P1 connection must be present!

Chime	Fan	Curtain	Blinds1	RFY	Security1	Camera	Remote	Tstat1	Tstat2	Tstat3	Tstat4	Radiator1	Security2	Async
Command	Receive P1		Transmit Async Port command											
Baudrate	115200													
Bits	8													
Parity	No													
Stopbits	1													
Polarity	Inverted													

Select the correct parameters for your smart meter:

Meter Brand	DSMR version	ID	Baudrate	Bits	Parity
Iskra ME382, MT382	2.2	/ISK5	9600	7	E
Iskra AM550	5.0	/ISK5	115200	8	N
Kaifa E0003,E0025,MA105,MA304	4.0	/KFM5	115200	8	N
Kamstrup 162,351,382	2.2	/KMP5	9600	7	E
Landis+Gyr E350 ZCF100,ZCF110,ZFF100,ZMF100	4.0	/XMX5LG	115200	8	N
Sagemcom XT210	4.0		115200	8	N

The smart meter connector type is RJ12. The Metering System holds a female connector, the customer can plug in a standard RJ12 or RJ11 plug.

RJ12 is a 6P6C (6 positions, 6 contacts)

RJ11 is a 6P4C (6 positions, 4 contacts) This one can be used to connect the RFXtrx433XL.

Pin #	Signal name	Description
1	+ 5V power	Power supply (not used by the RFXtrx433XL)
2	RTS	Request to Send
3	GND	Data GND
4	NC	Not connected
5	RxD	Data output to the RFXtrx433XL
6	GND power	Power GND (not used by the RFXtrx433XL)

RJ12 and RJ11 connections:

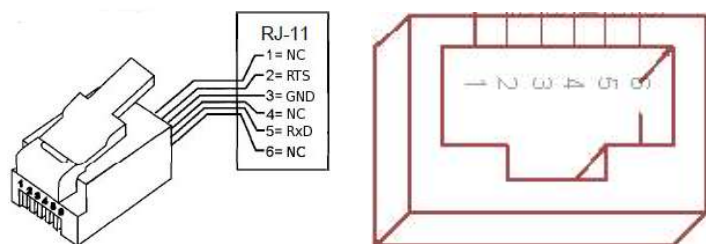

19.1. *DIY P1 connection for RFXtrx433XL batch 3618 and 4018*

1. Open the enclosure by removing the 4 screws.
2. Connect a 4k7 resistor between 3V3 and RxD.
3. Connect the RJ11 cable to the RFXtrx433XL PCB RFXtrx V5.0:
RJ11-2 to RTS
RJ11-3 to GND
RJ11-4 not used
RJ11-5 to RxD
4. Cut a few plastics from the upper side of the enclosure using a Stanley knife.
5. Cut also at the same position a few plastics from the bottom part.
6. Close the enclosure. First turn the screw left until you hear/feel a soft click, now turn the screw right and fix the screw (not too tight).

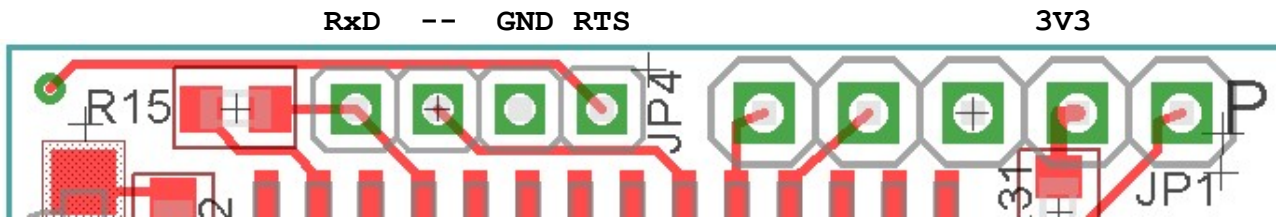

19.2. *DIY P1 connection for RFXtrx433XL batch 4918 and later*

1. Open the enclosure by removing the 4 screws.
2. Connect a 3k3 resistor between 3V3 and RxD
3. Connect the RJ11 cable to the RFXtrx433XL PCB RFXtrx V5.1:
RJ11-2 to RTS
RJ11-3 to GND
RJ11-4 not used
RJ11-5 to RxD
4. Cut a few plastics from the upper side of the enclosure using a Stanley knife.
5. Cut also at the same position a few plastics from the bottom part.
6. Close the enclosure. First turn the screw left until you hear/feel a soft click, now turn the screw right and fix the screw (not too tight)

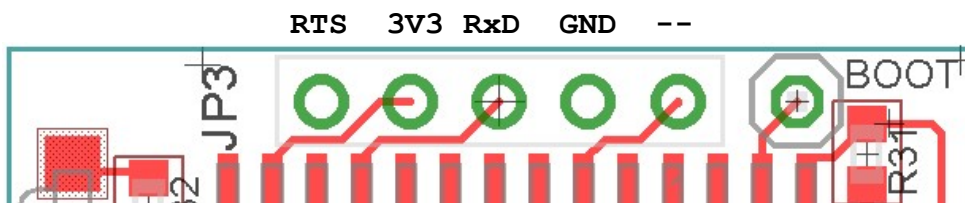

19.3. P1 option PCB Type 1 for RFXtrx433XL batch 3618 and 4018

1. Open the enclosure by removing the 4 screws.
2. Solder the 5 pins of the P1 PCB to the RFXtrx433XL PCB RFXtrx V5.0.
First solder 1 pin and check if the connector is fully on the RFXtrx433XL PCB.
Then solder the remaining 4 pins.
3. Cut a few plastics from the upper side of the enclosure for the cable using a Stanley knife.
4. Cut also at the same position a few plastics from the bottom part.
5. Close the enclosure. First turn the screw counter clockwise until you hear/feel a soft click, now turn the screw clockwise and fix the screw (not too tight).

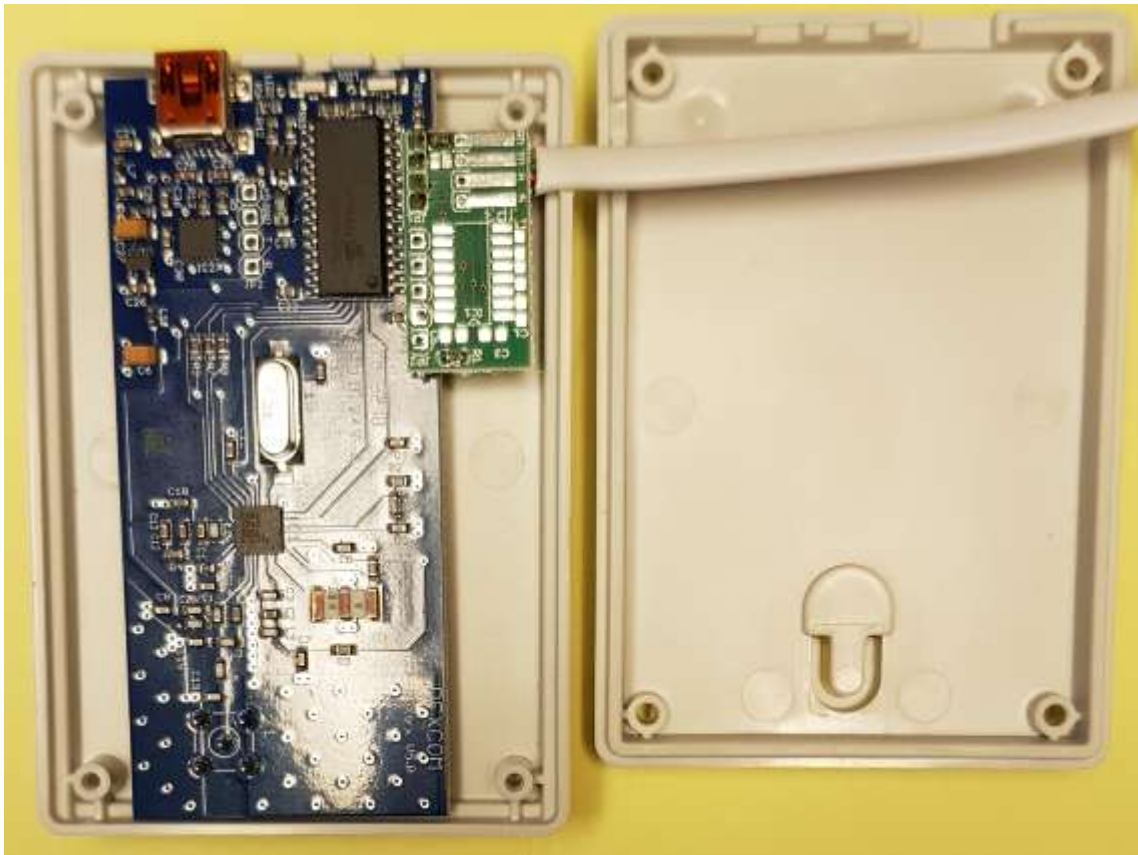
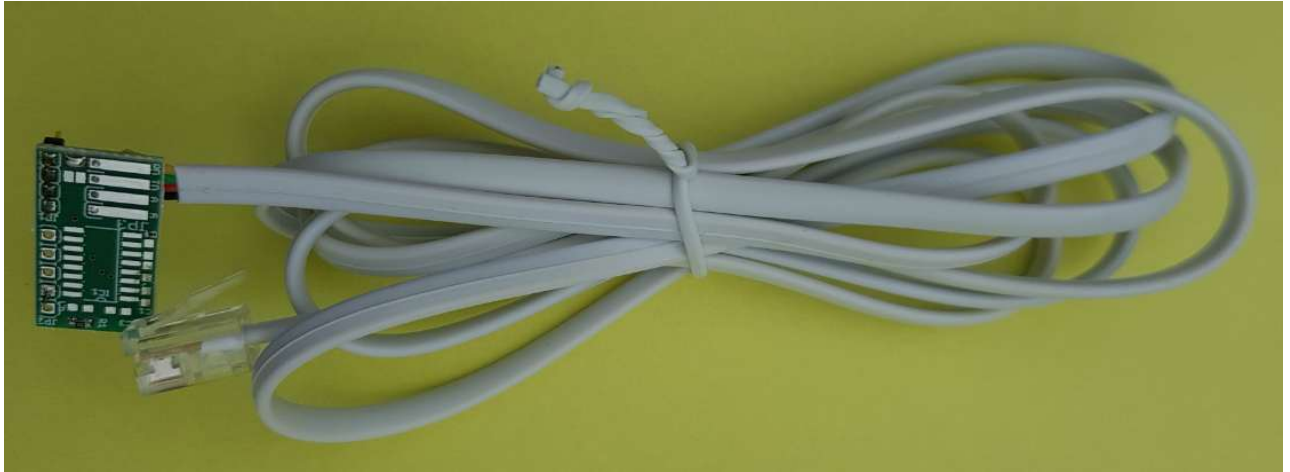

19.4. P1 option PCB Type 2 for RFXtrx433XL batch 4918 and later

1. Open the enclosure by removing the 4 screws.
2. Press the 5 pins of the P1 PCB into the RFXtrx433XL PCB RFXtrx V5.1.
Use a wrench to push the connector into the PCB until the black parts of the Press-Fit connector is on the RFXtrx PCB.
3. Cut a few plastics from the upper side of the enclosure for the cable using a Stanley knife.
4. Cut also at the same position a few plastics from the bottom part.
5. Close the enclosure. First turn the screw counter clockwise until you hear/feel a soft click, now turn the screw clockwise and fix the screw (not too tight)



19.5. RFXusb-RFX433 - P1 smart meter connection

The RFXusb_RFX433 can be connected to the Dutch P1 smart meter with a RJ11 cable.

Open the enclosure by removing the 4 screws.

If R7 and R9 are not present, solder a 3k3 resistor at R7.

Solder the RJ11 cable to the RFXusb-RFX433:

RJ11-2 to RTS

RJ11-3 to GND

RJ11-4 not used

RJ11-5 to RxD

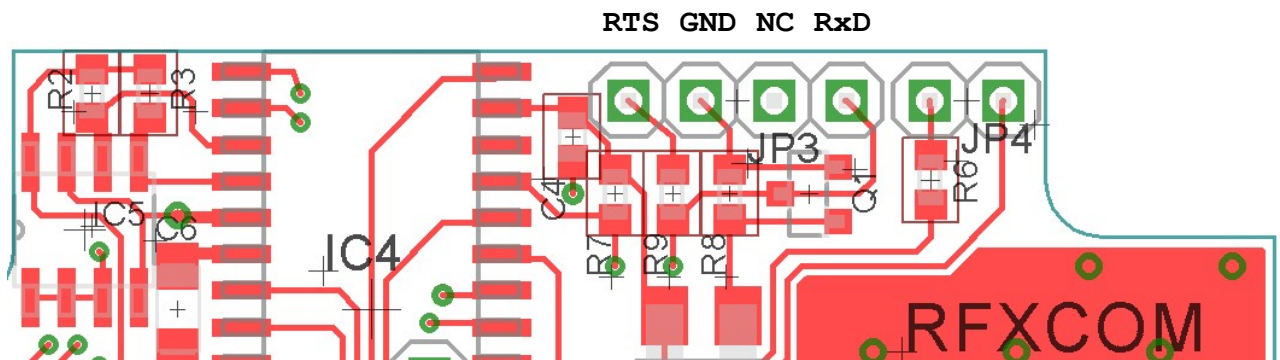

19.6. RFX433XL - P1 smart meter connection

The RFX433XL can be connected to the Dutch P1 smart meter with a RJ12 cable.

(If PCB is RFX ISS V2 and R7 is not present, solder a 3k3 resistor on this position)

Open the enclosure by removing the 4 screws.

Solder the RJ12 cable to the RFX433XL PCB

RJ12-1 to +5V

RJ12-2 to RTS

RJ12-3 to GND

RJ12-4 not used

RJ12-5 to RxD

RJ12-6 to GND

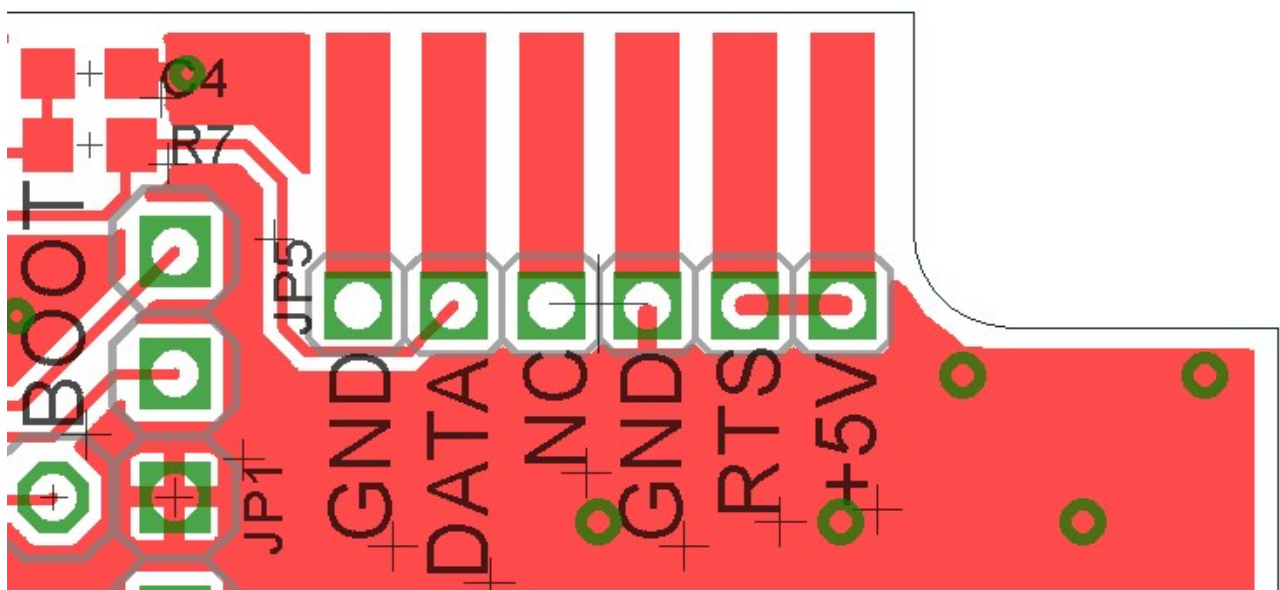

20. RFXtrx433XL - Teleinfo connection

The RFXtrx433XL can be connected to the French smart meter and needs a Teleinfo interface. At the moment we only supply the Teleinfo interface option only for the RFXtrx version 5.1 (this is on the PCB) which is delivered starting batch 4918 and the later batches xx19 (xx=01 to 52). The batch number is on the label on the backside of the enclosure.

This option cannot be added in the RFXtrx433XL batch 3618 or 4018!!

The connection can be tested in RFXmngnr.

Select the correct parameters and click "Transmit Async Port command".

Important: the Teleinfo connection must be present!

The setting is 1200, 7, Even, 1 and Normal polarity for the "historique" meter

The setting is 9600, 7, Even, 1 and Normal polarity for the new Linky meter

Fan	Hunter	Blinds1	RFY	Security1	Tstat1	Tstat2	Tstat3	Tstat4	Radiator1	Security2	Async
Command	Receive Teleinfo		Transmit Async Port command								
Baudrate	9600										
Bits	7										
Parity	Even										
Stopbits	1										
Polarity	Normal										

20.1. Teleinfo option PCB for RFXtrx433XL batch 4918 and later



1. Open the enclosure by removing the 4 screws.
2. Press the 5 pins of the P1 PCB into the RFXtrx433XL PCB RFXtrx V5.1.
Use a wrench to push the connector into the PCB until the black part of the Press-Fit connector is on the RFXtrx PCB.
3. Cut a few plastics from the upper side (only the raised edge) of the enclosure for the cable, using a Stanley knife.
4. Cut also at the same position a few plastics from the raised edge of the bottom part.
5. Close the enclosure. First turn the screw counterclockwise until you hear/feel a soft click, now turn the screw clockwise and fix the screw (not too tight)

21. RFXtrx433XL - Connection points for a serial interface

This connection can be used for a serial connection with the RFXtrx433XL instead of the USB interface.

The serial interface is using logic level of 5V maximum.

WARNING: Do NOT connect a RS232 interface that operates at +/-12Volts!!

Important: warranty is lost if this modification is used.

- Cut the PCB trace between the connection point R and the FT230X pin 15.
- Connect the serial interface to GND, T and R. Be sure to use a 3V3 or 5V logic level!
- The +5V can be used to power and external interface if required. In this case the RFXtrx433E must be powered by a 5V power supply connected to the USB interface. The +5V can also be an input for powering the RFXtrx433XL. Do not exceed +5V or the RFXtrx433XL will be destroyed.
- The serial interface is using 38400,N,8,1
- Be sure not to use a serial device that produces RF noise at 433MHz. A bad example of such a device is the USR-TCP232 LAN device.

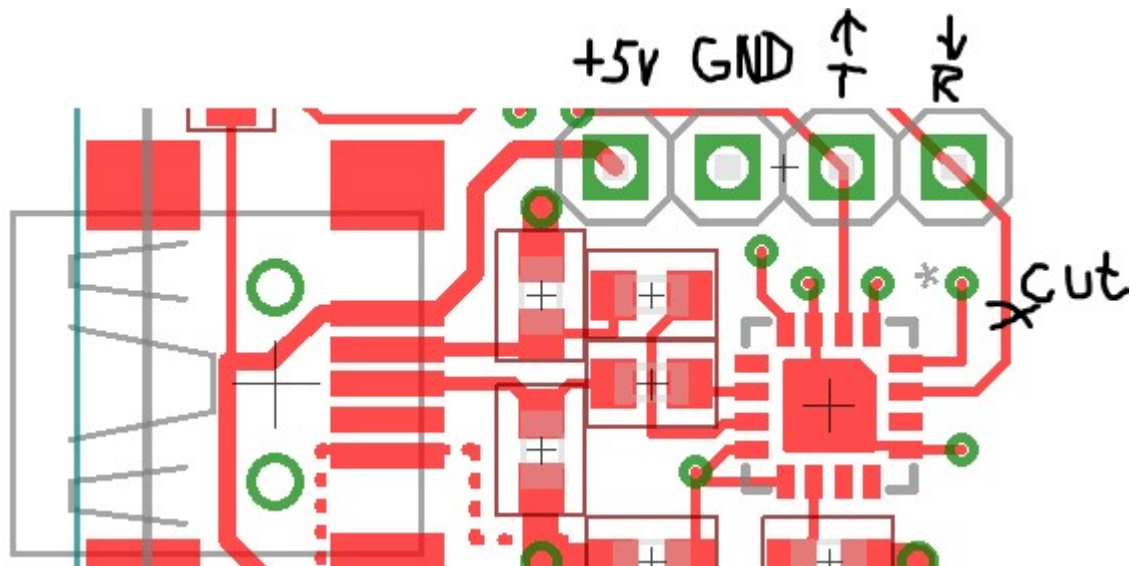

22. Recover from interrupted or wrong flash.

The RFXtrx can become in a loop after an interrupted flash or if you have flashed a wrong firmware. In this case the red LED stays on and no communication is possible.

1. Disconnect the USB,
2. Make a temporary connection (no soldering required) on the backside of the PCB as indicated below by the yellow connection,
3. Connect the USB,
4. Disconnect the temporary connection,
5. Start RFXflash and update the firmware.

RFXtrx433XL V5.1

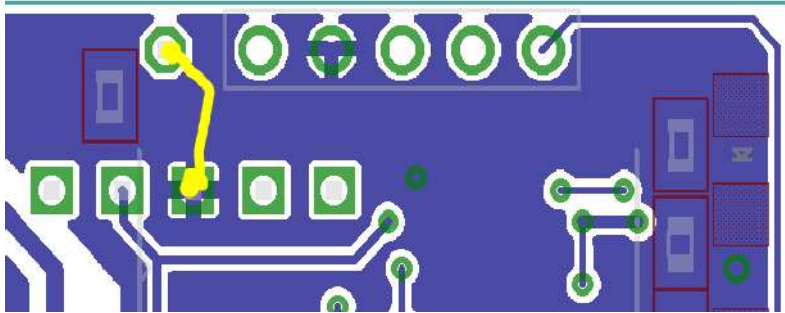

RFXtrx433XL V5.0

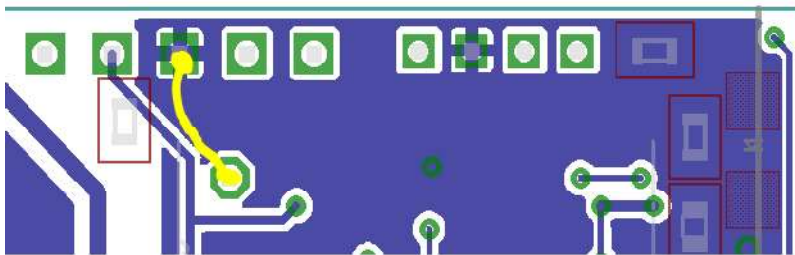

RFXtrx433E

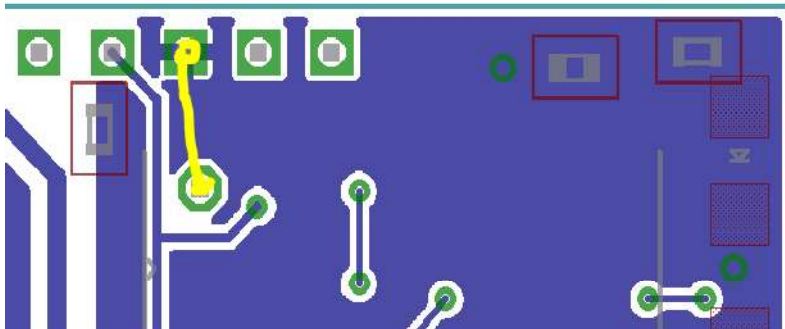

RFXtrx433

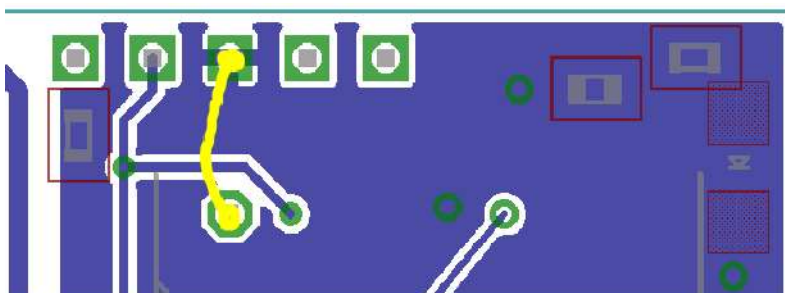

RFXtrx868X RFXtrxX V1.0 USB FT232

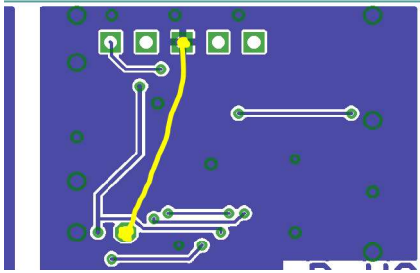

RFXtrx868X RFXtrxX V1.0 USB MCP2200

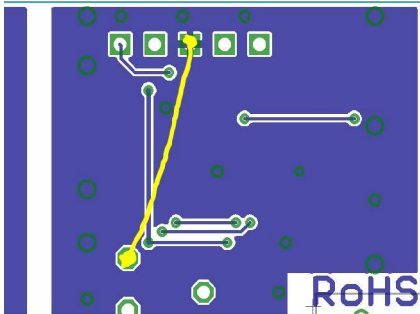

RFXtrx868XL RFXtrx V6.1 USB FT230QX

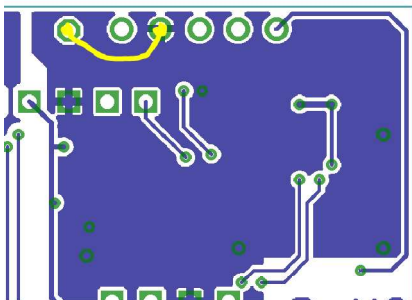

RFXusb RFX433, RFXusb RFX868

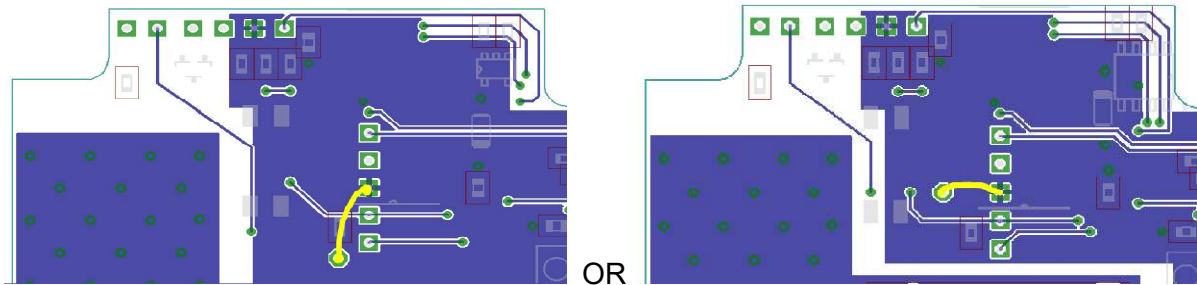

RFX433XL, RFX868XL

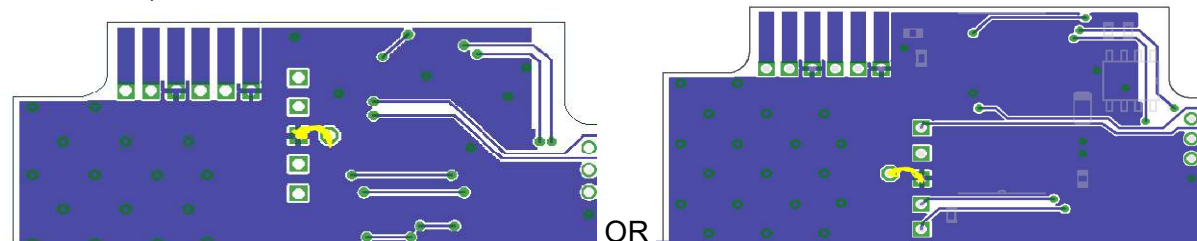

23. FAQ

23.1. Receive has stopped suddenly but transmit works.

Most probably a sensor is transmitting constantly. This could be for example an X10 MS13 motion sensor or weather sensor with almost empty battery. Or an outside weather sensor filled with water. Or a remote with a button pressed.

Test the RFXtrx with a remote or sensor on another location (> 1km away) using RFXmngn on a Windows system or laptop.

23.2. Can I increase the receive/transmit range of the RFXtrx?

First check chapter 2.5 for the best place for the RFXtrx antenna.

The switch board is not the best place for the RFXtrx because of all metal objects that will absorb or reflect the RF signals.

It is also advised to place the RFXtrx far away from PC's, routers, Raspberry PI ... because of the RF noise those products produce, and this will reduce the receive range very much.

You can connect another 50ohm 70cm/433MHz antenna with more gain.

For example, <http://www.ebay.com/itm/290979680030>

Install this antenna on a metal plate of at least 30 cm for optimum result.

23.3. The RFXtrx USB connection disconnects sometimes.

This happens mostly on Raspberry PI with a low-quality power supply. Solution is to use a powered USB hub with a good quality power supply.

It can also happen if the USB cable is running along a power cable or a power device is switched on that produces a high-power spike like a fluorescent tube. Solution is to separate the USB cable from all other cables and/or use a powered USB hub with a good quality power supply.

23.4. I have a 433.92MHz sensor/remote but this device is not received.

Besides the frequency the used protocol and modulation type is also important.

See chapter 2 for the list of supported devices.

23.5. The wall plug is switched by the remote, the remote is received but the RFXtrx does not switch the module.

The remote transmits several protocols. The protocol used by the wall plug is not received by the RFXtrx but some other protocols are received.

Solution:

For the HomeEasy EU- HE8xx series: reset the module to remove all paired remotes and pair the module with the RFXtrx433E and one of remote codes that is received.

For IT modules FA500/PROmax: Pair the RFXtrx433E with the module using an IT device and select a random ID. The received remote code can be used to know if the module is switched by the remote.

24. EC Declaration of Conformity

EC Declaration of Conformity



RFXCOM declares that the product:

RFX433

Brand: RFXCOM Type: RFXtrxUSB-RFX433, RFXusb-RFX433, RFX433XL

conforms with the essential requirements and other relevant provisions of the following directives and complies with the following standards applied:

RED 2014/53/EU	EN 300 220-1 EN 300 220-2
EMC Directive 2004/108/EC	EN 301 489-1 EN 301 489-3
LVD 2014/30/EU	EN 62368-1 EN 62311
RoHS 2011/65/EU	EN 63000

25. Warning:

- RF signals are possible disturbed, and it has not been justified for this equipment at uses in circumstances where life-threatening or dangerous situations are possible.
- RFXCOM HARDWARE AND SOFTWARE IS NOT INTENDED FOR USE IN THE OPERATION OF NUCLEAR FACILITIES, AIRCRAFT NAVIGATION OR COMMUNICATION SYSTEMS, AIR TRAFFIC CONTROL SYSTEMS, LIFE SUPPORT MACHINES OR OTHER EQUIPMENT IN WHICH THE FAILURE OF THE SOFTWARE COULD LEAD TO DEATH, PERSONAL INJURY, OR SEVERE PHYSICAL OR ENVIRONMENTAL DAMAGE.

26. License

- You are allowed to use RFXCOM software, protocols and Written Materials with RFXCOM hardware only.
- All copyright and other proprietary notices associated with RFXCOM software, protocols and Written Materials shall be visible to all users.
- You may not sell, distribute, loan, rent, lease, license, sublicense or otherwise assign or transfer RFXCOM software or RFXtrx protocols or Written Materials unless expressly authorized in writing by RFXCOM.
- You may not use any RFXCOM device, software or protocol as part of an exclusive or patented product without the express prior written permission of RFXCOM.
- You may not alter, modify, adapt or create derivative works based on any part of RFXCOM software or protocols or Written Materials in any way, including translating, reverse engineering, disassembling or decompiling the software.

27. Copyright notice

- All RFXCOM hardware, software, protocols and Written Materials are protected by copyright laws, and may not be reproduced, republished, distributed, transmitted, displayed, broadcast or otherwise exploited in any manner without the express prior written permission of RFXCOM.
- Netherlands Copyright and international treaty provisions protect the SOFTWARE, HARDWARE, RFXtrx protocols and Written Materials and shall be subject to the exclusive jurisdiction of the Netherlands Courts
- RFXCOM reserves all rights not expressly granted herein.

28. Revision history

- Version 0.0 – August 18, 2011
Initial version.
- Version 1.0 – October 30, 2011
RFXflash under Mono added.
- Version 2.0 – December 30, 2011
Updated for the production version with FTDI USB chip
- Version 2.1 – January 18, 2012
Link for ACM to serial port added in Linux instruction.
EC Declaration of Conformity added
- Version 2.2 – February 8, 2012
Protocols overview added
Screen dumps updated
- Version 2.3 – February 16, 2012
Novatys planned
- Version 2.4 – February 25, 2012
General information updated
- Version 2.5 – March 1, 2012
Chapter added how to run RFXmngr or RFXflash on Linux.
- Version 2.6 – March 14, 2012
Code tables added
Cresta, UPM added
- Version 2.7 – March 15, 2012
Flash procedure updated
- Version 2.8 – March 31, 2012
Phenix table added
- Version 2.9 – March 31, 2012
AB400 and Phenix address extended
- Version 2.10 – April 16, 2012
Linux USB - tty configuration updated
- Version 2.11 – May 14, 2012
List of supported protocols updated.
- Version 2.12 – June 8, 2012
Chapter added how to run RFXmngr or RFXflash on Mac OS
- Version 2.13 – July 15, 2012
List of supported protocols updated
- Version 2.14 – August 4, 2012
List of enabled protocols influence added
RFXtrx315 added
- Version 2.15 – August 18, 2012
Enabled protocols table changed
- Version 2.16 – August 26, 2012
Rubicson stektermometer added
ATI Remote Wonder II added
- Version 2.17 – August 28, 2012
Table “sensitivity influenced” updated
- Version 2.18 – September 18, 2012
Chapter 2.3 updated: BlindsT0 disables all other protocols
- Version 2.19 – September 25, 2012
RFXFlash version required changed to 4.0.0.0
- Version 2.20 – September 28, 2012
RF range reduction guide added
- Version 2.21 – October 18, 2012
BlindsT2 and BlindsT3 added
- Version 2.22 – October 24, 2012
Sartano added
- Version 2.23 – October 31, 2012

Sensitivity table updated
Version 2.24 – November 7, 2012
Protocol table extended with the protocols to enable for receive
Version 2.25 – November 14, 2012
HE105 switch settings added
Version 2.26 – November 28, 2012
undec on explained
Version 2.27 – December 4, 2012
Use of Lighting4 commands for undec ARC
Brennenstuhl added
Version 2.28 – December 18, 2012
Receiver tab removed from RFXmng
Version 2.29 – December 27, 2012
Lighting4 receive added
Version 2.30 – January 1, 2013
Raex motor added
Version 3.00 – January 4, 2013
RFXtrx433 Type1/Type2 firmware added
Version 3.01 – February 4, 2013
Supported protocols list updated
Version 4.00 – February 21, 2013
Chapter 8 - Lighting4 screen updated for RFXmng 11.0.0.0
Known Lighting4 chapter added
Version 4.01 – March 13, 2013
Receive of LaCrosse sometimes influenced by enabled Hideki
Version 4.02 – June 8, 2013
MDREMOTE LED dimmer added
Conrad RSL2 added
Energenie added
Version 4.03 – September 27, 2013
How to find the MDREMOTE ID (chapter 7.6)
WS1200 added
Byron SX Chime added
Version 4.04 – November 15, 2013
Maverick ET-732 added
Alecto SA30 added
Oregon EW109 added
Revolt added
Version 4.05 – December 5, 2013
Blyss command explanation added.
Lighting4 - Mercury added
Lighting5 – dx.com RGB LED controller added
Version 4.06 – December 27, 2013
Chapter 2.2 updated
Version 4.07 – February 10, 2014
Chapter 7.8 added: how to find the dx.com RGB LED strip driver ID
Version 4.08 – March 20, 2014
ARC and Oregon3.0 updated in table 2.4.
Energenie 5-gang 429.950 added
Version 4.09 – April 4, 2014
BlindsT6 - DC106, YOODA, Röhmotor24 RMF added
Version 4.10 – April 7, 2014
BlindsT7 - Forest added
Version 4.11 – April 28, 2014
RGB LED – clarified AD is LightwaveRF
Version 4.12 – May 21, 2014
Kambrook RF3672 added
RFY protocol added

Somfy programming instructions added
 Supported protocol list RFXtrx433 updated.
 Protocol list by function added
 Version 4.13 – May 31, 2014
 Opus TX300/Imagintronix Soil sensor added
 Version 4.14 – June 18, 2014
 Prega sensor added
 Conrad 34911 Lighting4 coding added
 Version 4.15 – June 25, 2014
 Kambrook, Rubicson, Viking supported in ext firmware
 Number of RFY remotes increased from 16 to 30
 Version 4.16 – June 29, 2014
 RFXmngn cannot be used on Linux
 Version 4.17 – July 3, 2014
 CoCo GDR2 added
 Version 4.18 – July 14, 2014
 Opus TX300 link added
 Version 4.19 – July 25, 2014
 Aoke relay added
 Version 4.20 – August 25, 2014
 Enabling protocols clarified.
 Version 4.21 – September 5, 2014
 Meade sensors added
 Oregon BTHGN129 sensor added
 Version 4.22 – September 18, 2014
 Eurodomest added (NL - Action)
 Byron MP001 added
 WT0122 added
 Procedures added to find the Eurodomest and TRC02 ver2 ID
 Version 4.23 – September 24, 2014
 Proove TSS330 fridge/freezer sensor added
 Version 4.24 – October 9, 2014
 BlindsT0 added in ext firmware
 Alecto WS1700 and compatibles added
 Version 4.25 – December 13, 2014
 Smartwares radiator valve added
 Proove TSS320 sensor added
 Version 4.26 – January 2, 2015
 SelectPlus200689101 White Chime (Action NL) added
 Version 4.27 – January 6, 2015
 SelectPlus200689103 Black Chime (Action NL) added
 Version 4.28 – January 7, 2015
 Proove outdoor sensors 311346 & 311501 added
 Etekcity Wireless Remote Control Outlet Switch (US)
 Version 5.00 – January 10, 2015
 Copyright message updated
 License chapter added
 RFXmngn information updated
 Version 5.01 – February 27, 2015
 Chapter 2.5 Lighting4 receive is reduced with HomeEasy EU enabled.
 Chamberlain tubular motor added
 Sunpery blind motors added
 DEA Systems receivers added
 Envivo ENV-1348 chime added
 Alecto WS4500 added

Version 5.02 – March 18, 2015
 1byOne Easy Chime added
 BTX blind motors added
 Dolat DLM-1 blind motors added
 OTIO added

Version 5.03 – March 19, 2015
 TFA 30.3160 pool sensor added

Version 5.04 – April 14, 2015
 Chapter 4 updated with restrictions on Lighting4
 Siemens SF01 LF959RA50/LF259RB50/LF959RB50 extractor hood added
 Maplin N78KA added

Version 5.05 – May 2, 2015
 Dooya blind motors added
 Louvolite one touch motorised blinds added
 Alecto WS3500 added

Version 5.06 – May 4, 2015
 Current dx.com TRC02 LED drivers have a different protocol and are not supported.

Version 5.07 – June 1, 2015
 WH2 temperature humidity sensor added
 RGB LED controller <http://www.ebay.com/itm/191481664563> (maybe dx.com 227892)

Version 5.08 – July 31, 2015
 Oregon MSR939 added
 ESMO blind motors added
 Brel blind motors added
 Blinds T6 type motors now also supported in Ext firmware
 Supported devices table 2.2.2. updated

Version 5.09 – Aug 12, 2015
 Luxaflex blind motors added

Version 5.10 – Aug 17, 2015
 JVS screen motors added
 Livolo NL link added

Version 5.11 – Aug 31, 2015
 ASA motors added

Version 5.12– Sept 14, 2015
 Home Confort added

Version 5.13– Oct 2, 2015
 Oregon GR101 received in Type1 firmware
 Conrad RSL sensors received in Type2 firmware

Version 5.14– Oct 7, 2015
 Quotidom blinds motor added

Version 5.15– Nov 06, 2015
 Banggood temp-hum sensor added
 Legrand CAD radio added

Version 5.16– Nov 26, 2015
 Proluxx codes corrected

Version 5.17– Dec 24, 2015
 RFXflash procedure updated
 Rubicson pool sensor 48.019 added
 Inovalley SM80 plant sensor added
 Lucci Air fan added

Version 5.18– Jan 1, 2016
 1byone Drive Way alarm added

Version 5.19– Feb 6, 2016
 Avantek added
 ASP blinds motors BlindsT11 added
 Maverick ET-733 added
 Profiles PAC-326R Belcanto chime added
 HQ COCO-20 added

Version 5.20– Feb 18, 2016
BlindsT12 Confexx CNF24-2435 added
IT FA500, PROmax... added
Ext2 firmware overview added in chapter 2
Auriol Z31055B-TX added
Chuangou, Eminent security sensors added

Version 5.21– May 6, 2016
Cartelectronic TIC and Encoder added
FAQ chapter added

Version 5.22– May 14, 2016
Corrected: TX95 is using the Rubicson protocol
MDRemote V108 added

Version 5.23– June 10, 2016
Motolux blinds motor added
Auriol H13726, Hama EWS1500, Meteoscan W155/W160, Ventus WS155 added
FAQ updated

Version 5.24– June 21, 2016
Seav TXS4 added

Version 5.25– Aug 6, 2016
ORNO added

Version 5.26– Sept 6, 2016
Added: How to find the SEAV TXS4 ID

Version 5.27– Oct 09, 2016
Westinghouse fan 7226640 added
THN129 added
TFA 30.3056 pool sensor added

Version 5.28– Oct 19, 2016
MCZ pellet stove added
Alecto SA33 added
Smartwares RM174RF smoke detector added

Version 5.29– Nov 27, 2016
SilverCrest 91089 added
Mertik G6R-H4S added
Marquant 943134
MCZ pellet stove instructions added

Version 5.30– Dec 6, 2016
Kerui security sensors added
Screenline added

Version 5.31– Dec 15, 2016
Flamingo smartwares SF501 added

Version 5.32– Jan 02, 2017
Kangtai, Cotech added

Version 5.33– Feb 01, 2017
Cranenbroek added
Unitec 48110 EIM 826 added
SilverCrest 60494 added
WSD10 added

Version 5.34– March 08, 2017
Housegard Origo smoke detector added
Pearl NC-7159 added
Ambient Weather & Froggit F007TH added
TFA 30.3208.02 sensor added

Version 5.35– March 20, 2017
Silverline Premium motor added
Dooya DT82 instructions added

Version 5.36– April 25, 2017
Quigg added
OTIO EHS5050 added
Blyss temperature/humidity sensor 630467 added
Outlook Motion Blinds added

Version 5.37– May 5, 2017
Cartelectronic TIC in Type2 and Ext2

Version 5.38– May 22, 2017
BBSB not in Ext2
Profile Qnect added

Version 5.39– July 28, 2017
Banggood DANIU sensor added
Somfy usage remarks added
Brennenstuhl RC2044 added

Version 5.40– Sept 18, 2017
Blyss temp/hum added in Ext
Cartelectronic Linky added

Version 5.41– Sept 24, 2017
Sonoff RF added
Rollertrol G series added

Version 5.42– Oct 26, 2017
Dooya DC2770, DT52E added

Version 5.43– Nov 1, 2017
A-OK AC127, AC129 added

Version 5.44– Nov 11, 2017
Digoo DG-R8H added

Version 5.45– Nov 23, 2017
SilverCrest 284705 added

Version 5.46– March 2, 2018
Nexa NBA-001 added
Kimex projection screen added

Version 5.47– March 13, 2018
Lighting4 PT2262 EV1527 info added
Telldus Thermo/Hygro sensors 313159 and 313160

Version 5.48– July 28, 2018
Supported Protocols list updated
FunkBus (Gira, Jung, Berker, Insta) added
Nobily rolladenmotor added
LucciAir DC added

Version 5.49– Aug 18, 2018
Supported Protocols list updated

Version 5.50– Sep 26, 2018
Cotech Ekstra temperaturgiver/hygrometer added
Supported Protocols list updated for RFXtrx433XL

Version 5.51– Sep 28, 2018
RFXtrx433XL Dutch P1 smart meter connection added

Version 5.52– Oct 3, 2018
RFXtrx433XL serial connection added

Version 5.53– Oct 12, 2018
P1 smart meter connection updated
RFXtrx433XL French Teleinfo connection added
Mertik G6R-H3T1 added

Version 5.54– Oct 16, 2018
Teleinfo interface circuit added

Version 5.55– Oct 17, 2018
Firmware recovery procedure added

Version 5.56– Nov 3, 2018
P1 and Teleinfo resistor R15 change added

Version 5.57– Nov 30, 2018
P1 and Teleinfo updated

Version 5.58– Dec 2, 2018
How to move RFX devices to another RFXtrx433E or RFXtrx433XL

Version 5.59– Jan 5, 2019
Funkbus transmit only
Motiva blinds added
Envivo chime added in XL
Byron BY chime added

Version 5.60– April 03, 2019
P1 DIY cable connection added
P1 option boards added
RFXtrx868 supported protocols updated
Alfawise and dBell added
inblindz added
Homeconfort, Siemens SF01 receive added
Bresser Temeo Hygro added
Digoo door/window sensor added
Monaco wireless doorbell added
CasaFan Eco Aviatos RH787T added
Motostar blinds added

Version 5.61– April 25, 2019
Procedure how to move RFX devices updated.
Teleinfo option PCB added.

Version 5.62– May 04, 2019
RM174RF, RM175RF added in Pro firmware

Version 5.63– May 07, 2019
Omnia Go blinds added
Teleinfo setting – Inverted polarity

Version 5.64– July 23, 2019
Faher blinds motor added
Profitec KD310T added
Kerui siren added
RM174RF, RM175RF transmit added

Version 5.65– Aug 12, 2019
Recover RFXtrx868 added
Hunter fan added
Novy extractor hood added

Version 5.65a– Aug 12, 2019
MCZ receive updated in 2.2.2.

Version 5.66– Sept 30, 2019
Smartwares RM174RF/RM175RF receive only
Teleinfo interface updated

Version 5.67– Jan 11, 2020
Simu Hz indicated (BHz is not supported)
Dooya Bi-Directional is not supported!
SAS SA-200 added
RAIN9 - TFA 30.3233.01 rain sensor added
Gaposa QCTR5

Version 5.67a– Feb 5, 2020
The new TFA rain sensor 30.3233 only supported in Pro2, ProXL1 and ProXL2

Version 5.68– Feb 26, 2020
Cherubini added

Version 5.69– June 2, 2020
Cherubini ID 10 xx xx added

Version 5.70– Dec 15, 2020
 Louvolite one touch Vogue vertical blinds added

Version 5.71– April 7, 2021
 ProXL2 firmware added
 Ozroll E-Trans added
 Bresser 7009981, 7009994, 7009997 added
 1byOne QH A19 rev10 added

Version 5.72– March 22, 2022
 Ikea Koppla added in Pro2
 Byron DBY-23711B added
 Gazco heater added

Version 5.73– July 12, 2022
 TFA Pro 35.1161, 30.3249.02, 30.3233.01, 30.3251.10
 LaCrosse TX141TH, TX141W, WS1652, TX145R

Version 5.73a– Aug 8, 2022
 Not in ProXL2:
 - TFA Pro 35.1161, 30.3249.02, 30.3233.01, 30.3251.10
 - LaCrosse TX141TH, TX141W, WS1652, TX145R

Version 5.74– Nov 3, 2022
 - TFA 30.3247.02 added
 - Itho CVE ECO RFT (RFXtrx868) added
 - Orcon (RFXtrx868) added

Version 5.75– Dec 23, 2022
 - RFX433 and ProXL69 added

Version 5.76– Jan 1, 2023
 - RFX868 – Alecto5500 changed to FineOffset

Version 5.77– Jan 20, 2023
 - RFXtrxWifi information added

Version 5.78– Jan 30, 2023
 - RFX433/RFX868 boot load recovery added

Version 5.79– Feb 24, 2023
 - RFX433 firmware list updated

Version 5.80– May 7, 2023
 - Siemens SF01 ID added
 - Rain sensor added

Version 5.81– June 10, 2023
 - RFX310 added

Version 5.82– July 1, 2023
 - P1 connection for RFXusb-RFX433 and RFX433XL added.

Version 5.83– July 21, 2023
 - Brel, Dooya, Motionblinds, Yooda bi-directional added

Version 5.84– August 31, 2023
 - Wifi chapter updated

Version 5.85– Sept 5, 2023
 - Jysk Huglo added

Version 5.86– Oct 6, 2023
 - Instruction added how to install the Wifi module.

Version 5.87– Nov 1, 2023
 - Lists of supported protocols updated
 - Wifi restore text updated

Version 5.88– Jan 26, 2024
 - Lists of supported protocols updated

Version 5.89– July 5, 2024
 - Firmware recovery RFXLAN added

Version 5.90– July 27, 2024
 - Cherubini config added

Version 5.91– Nov 11, 2024
 - Gaviota added

Version 5.92– March 6, 2025

- Bresser 7009998 added

Version 5.93– July 12, 2025

- DDxxxx changed to DD27xx

Version 5.94– Nov 19, 2025

- RFXtrx types added to the alphabetic list